

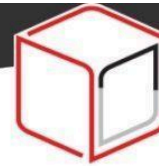
# STEP Robot Pallet Wrapper Brake (Manual)



CE

43011010 Manual UK 290622  
Copyright © Sal-Tech 2022





## **COMPANY INTRODUCTION**

"We believe packaging solutions for our customers should be simple, easy to use, ergonomic and sustainable.

We offer a wide range of packaging products and solutions, and web design and engineer production lines specifically built to your needs.

Our motto is simple: Sal-Tech Easy Packaging makes your life simpler through engineering and good design, and your job less stressful. We Keep Things Together."

**Gunnar Salbæk**  
Owner/CEO

## **About Sal-Tech Easy Packaging**

Sal-Tech Easy Packaging offers a wide range of solutions for simple and reliable packaging of your products.

If it is a standard or a special solution that's needed for your assignment, we have a creative input to solve your needs, securing you an up-to-date packaging application.

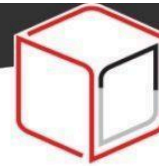
Sal-Tech Easy Packaging is 100% owned by Gunnar Salbæk,

CVR no.: DK18429098 Salbæk Easy Packaging v/Gunnar Bjørn Salbæk.

Our team works together on a 100% virtual platform and therefore please forward all correspondence and invoices to [support@sal-tech.com](mailto:support@sal-tech.com).

Bank connection: Nordea Denmark.





## 1. SAFETY INSTRUCTIONS

### Before use

- Read these instructions carefully.
- Keep the manual and related technical information carefully for future reference!
- Observe the safety precautions.
- Set the technical parameters in strict accordance with the specifications given in the manual.
- Preventive and corrective maintenance of the machine must only be performed by qualified personnel.
- Use the self-propelled robot exclusively for the use for which it was designed and built, as indicated in this manual.

### During use

- Do not wear loose clothing - they can get trapped in the machine.
- Do not touch moving parts while the machine is running.
- Stay out of the movement area of the machine after starting it. Approach only after this is done the work cycle.
- Keep your hands at an adequate distance from moving parts. If necessary, use suitable protective gloves.
- When working, use hand protection (cut-proof gloves).
- Do not carry out maintenance work when the machine is in motion.
- Do not use water! Do not use water or steam to clean the appliance.

### After use

- Do not remove or cover the warning or information plates on the machine.
- Use the machine as indicated in this manual.
- Turn off the machine via the control panel using the special key supplied with the robot.

### Rules for assistance and maintenance

- Keep a record (possibly on a computer) of assistance and maintenance interventions, with relative dates.
- Before maintenance, make sure that the machine is turned off and there are no people or things near it.
- The use of non-original spare parts cancels any warranty and civil liability provision.
- Power the batteries of the winder with voltage, current and electrical frequency as required by the machine itself.
- Do not change settings or add lubricants while the machine is running.
- Do not make any modifications to the machine.

### Accident prevention warnings

- Pay attention to the rotation of the robot during the work cycle.
- Pay attention to the movements of the reel holder carriage.



## 2. GENERAL INFORMATIONS

### 2.1 Installation notes

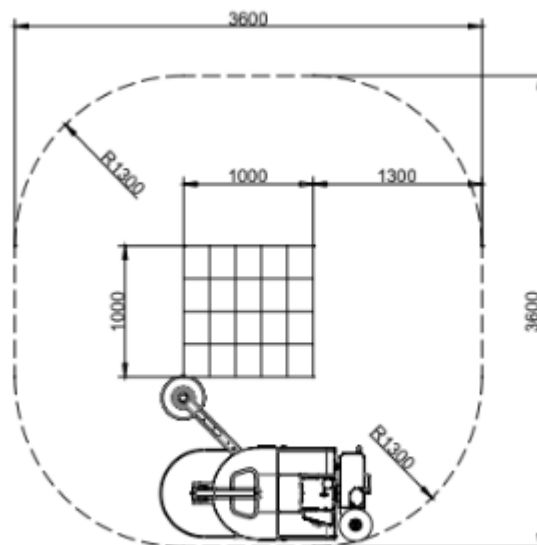
To ensure safe and correct operation, please check the following conditions before starting the machine:

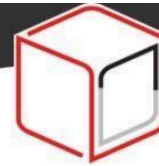
1. The capacity of the battery power source must be suitable for the requirements of the machine.
2. Battery charge is 110v / 220v (+ - 10%)
3. Battery charging in Hertz is 50/60 Hz. (+ - 2%)
4. The robot can be used at a temperature between 0 ° C / + 40 ° C
5. There should be no vibrations next to the machine during its operation and make sure the ground is level.

### 2.2 Notes to be observed before using the machine

Per garantire un utilizzo in sicurezza della macchina da parte dell'operatore, si prega di leggere che le seguenti condizioni:

1. Before using the product, carefully read the operation manual of the machine.
2. It is necessary to fully charge the battery before using the machine.
3. Make sure that no object is placed on the upper unit of the film reel holder carriage.
4. Avoid wet objects or water around electrical parts.
5. Check that there is no film wound irregularly inside the reel holder carriage or around the machine.
6. Do not stop or cross (indicated below) the machine while it is in operation.
7. When a problem occurs, refer to the Troubleshooting section of this manual.





## 2.3 General safety notes

### 1 BASIC OPERATIONS

The manual and the safety notes must be read before working on the machine. The manual must always be near the machine. The interventions for maintenance and inspections must be respected.

This machine was built in compliance with all safety standards.

If not used properly, it can cause injury to the operator or to nearby people. Furthermore, improper use can cause damage to the machine itself or to things close to it.

### 2 GENERAL PRECAUTIONS

The user must be trained in all other legal regulations and other generally applicable mandatory provisions relating to accident prevention and environmental protection in addition to instructions for use

For safety reasons, long hair must be tied up, no jewelry must be worn, and clothes must

fit snugly. Use the protective equipment required by circumstances or by law,

Observe all safety instructions and warning labels on the machine, making sure they are always legible.

Always make sure that people during training to work with the machine are constantly supervised by an expert.

Work on the electrical parts must only be carried out by an experienced electrician or under the supervision of an experienced electrician in accordance with the rules in force.

### 3 SAFETY INSTRUCTIONS RELATING TO SPECIFIC OPERATIONAL PHASES

Avoid any operation that may not be safe. Take all precautions to ensure that the machine is used safely and properly.

Only work on the machine with safety equipment, including detachable safety devices, emergency stop equipment, noise shields and fire protection devices. Check the machine for defects every time you change your work shift. Any changes in the behavior of the machine must be immediately reported to the competent person.

If necessary, stop and lock the machine immediately. In case of malfunction the machine must be stopped and blocked until the problem is solved.





Make sure no one is at risk before turning on the machine. All personnel working on the machine must be instructed on all phases of operation and safety.

Always tighten screws after repairs or maintenance.

After maintenance or repairs and before putting the machine into operation, all safety devices must be reinstalled and checked in their operation.

To minimize the environmental impact, all consumables and replaced parts must be disposed of responsibly.

Before starting the machine, check that the accessories have been stored safely. Do not attempt any operation that could pose a risk to the stability of the machine.

#### **4 WARNINGS ABOUT ELECTRICAL HAZARDS**

Any electrical work must be carried out by an experienced electrician or under the supervision of an experienced electrician. All work must be carried out according to the rules of electrical engineering and respecting local wiring standards and rules.

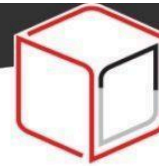
Check the electrical circuits at regular intervals. Tighten any loose connections. Check wiring for burn marks; replace burnt cables and determine and correct the reason for overheating.

If forced to work on the live machine, make sure that a second person is present who can cut off the power supply in an emergency. Use insulated tools for electrical work.

Before performing work on assemblies with electrical voltage present, turn off the power supply. Carefully discharge the power cord and short circuit energy storage components such as capacitors.

If the equipment has been disassembled, carefully reassemble all its parts before re-activating the power supply.





### 3. CHARACTERISTICS OF THE MACHINE

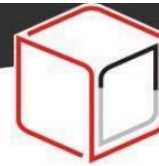
#### 3.1 Technical characteristics of the machine

ITEM	PARAMETER	
	STEP ROBOT PALLET WRAPPER BRAKE	STEP ROBOT PALLET WRAPPER 300%
Power supply	1 kW	1,25 kW
Battery charging in Hertz	1. 50/60 Hz. (+- 2%)	
Pre-stretch (%)	Mechanical brake carriage	300% & 230% two step change by handle (250% and 200% option)
Turnable speed	35 - 90 mt/min.	
Carriage up / down speed	1,4 - 5 mt/min.	
Lifting speed of the truck	Adjustable from touch panel	
Film cut	Manual	Automatic (if present)
Max. product dimension (W*L) mm	∞	
Min. Max. product dimension (W*L) mm	600 x 600 mm	
Machine size	1610 x 1253 x 2790 mm (Standard column from 2400)	
Surroundings	Moisture <90%; temperature from°C a +40°C	
Machine weight	450 Kg.	

#### 3.2 Stretch film parameter

FEATURES	PARAMETERS
External diameter of reel	280 mm
Height of reel	500 mm
Thickness of film	12 - 35 my
Internal diameter of reel	76 mm
Weight of reel	16 Kg.





**The main types of films that can be used are:**

- A. Single-sided stretch film (1 in Fig.1.2)
- B. Double-sided stretch film (2 in Fig.1.2)

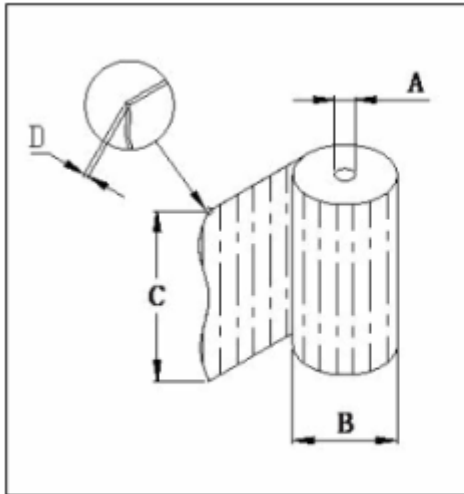


Fig 1.1

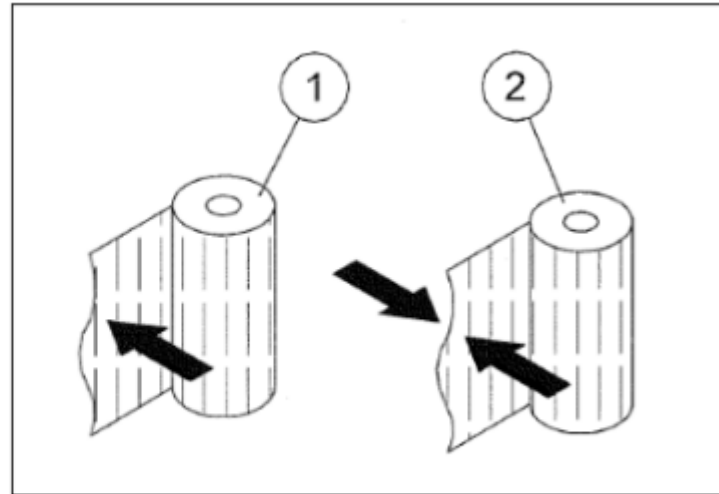
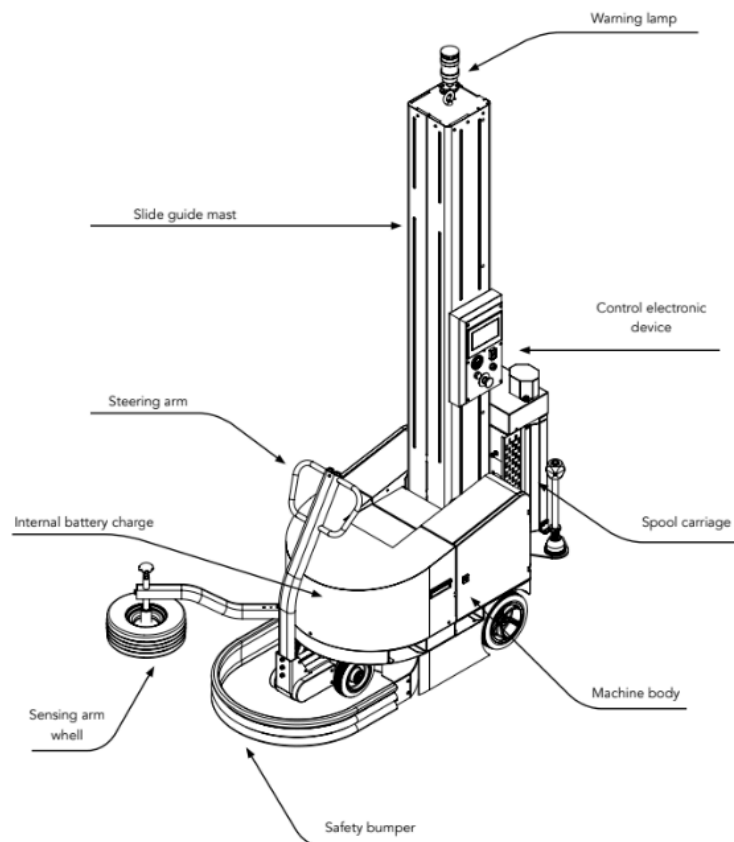
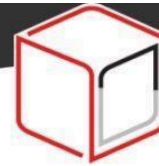


Fig 1.2

**3.3 Main parts**





## 4. Setting up and handling of the machine

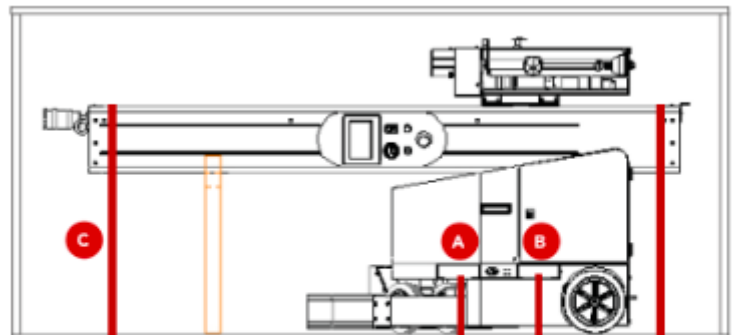
### 4.1 Preparation

Refer to Fig. 1.3 and Fig. 1.4 to see the appearance of the machine in its eventual packaging. The machine can be packed in a wooden crate or on a platform. After removing the packaging, check the following:

- No pieces have fallen into the packaging;
- That the model of the machine is the correct one;
- The user manual with the declaration of conformity is present;
- There are no transport damage.

#### Packed in wooden crate

To remove the machine from its packaging, carefully open the top cover of the packaging and then the side parts. Remove the strap C anchoring to the pallet and lift the machine using a forklift truck in the appropriate side entrances indicated by letters A and B



#### Packing on platform

To remove the machine from the platform, carefully remove the film with the protective foam wrapped around it. Remove the strap C anchoring to the pallet and lift the machine using a forklift truck in the appropriate side entrances indicated by letters

A and B

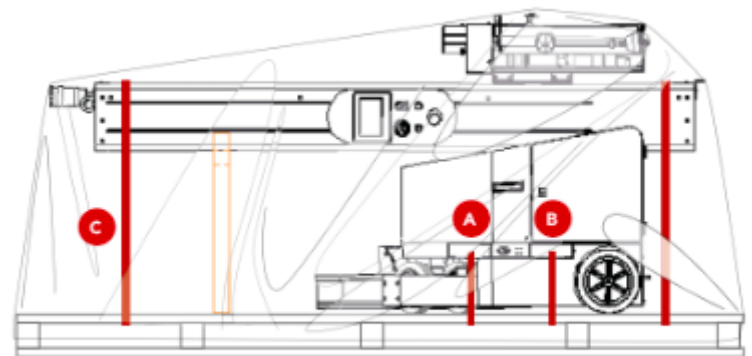


FIG. 1.4 Packing on platform

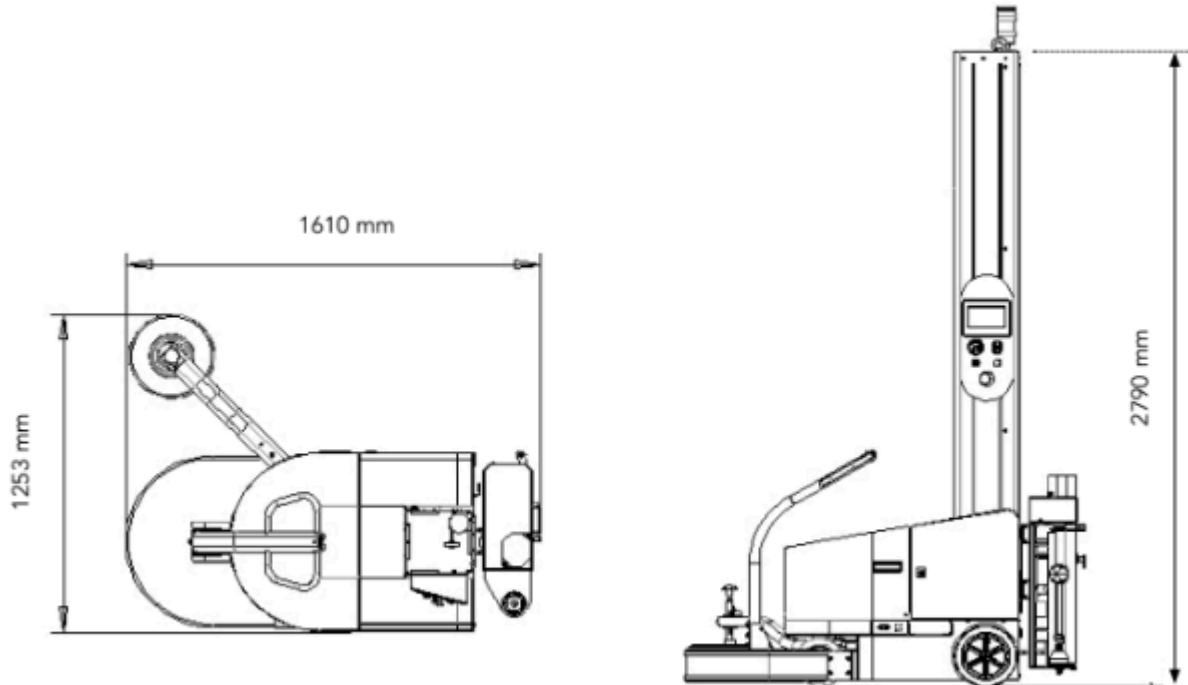
### 4.2 Machine identification plate

Each machine distributed by us is equipped with an identification plate on which the data of the distributing company are shown with the related data of the item sold. (FIG 1.5).

If the user wants to contact the manufacturer for anomalies or information, please provide the model name and the serial number of the machine shown on the identification plate.



### 4.3 Standard machine layout and dimensions



### 4.4 Safety Precautions

#### 4.4.1 Precautions on using the machine

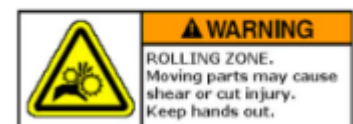
1. Check that the power supply for recharging the batteries is suitable for that required by the machine. Do not insert the plug into the socket if the power supply voltage is incorrect. This machine adopts 220V single phase system with dual color ground wire to prevent current leakage.
2. Stand sideways to the machine during its starting and check that there are no people or things in front of it.
3. Do not place or operate the machine on soft, unstable or sloping surfaces.
4. Position the pallet to be wrapped sideways to the machine in contact with the feeler wheel.
5. At the end of the working cycles, always remember to switch off the machine.
6. In an emergency, press the emergency button to stop the machine immediately.
7. Clean the machine daily after its use.
8. Do not remove electrical equipment randomly: not only the operation of the robot is compromised, but also the safety for the operator.
9. The inspection and maintenance of electrical equipment is permitted only to qualified personnel.

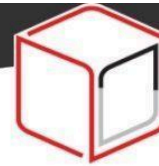
#### 4.4.2 Warning signs and symbols

##### Mechanical danger

It is forbidden to remove or replace this warning sign. Indicates an area with moving rollers. Be sure to turn off the machine before making repairs. The machine has two warning signs: one is placed at the base of the upright, the other at its top. See Fig.1.6

FIG. 1.6








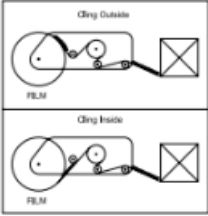
### Electrical hazard

This danger sign is placed on the door of the electrical panel. Indicates the danger of electric shock if the door is removed. It is forbidden to replace or remove the label. See Fig.1.7

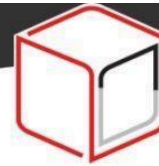


FIG. 1.7

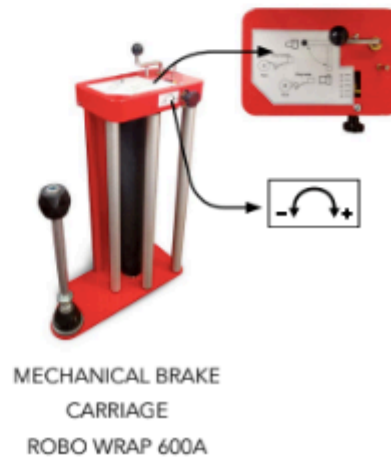
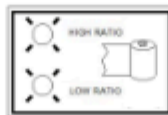
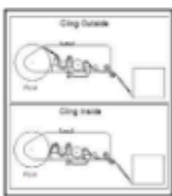
### Generic signage

 <p>Indicates where the machine can be lifted by the forklift.</p>	 <p>Indicates the voltage of the power supply for charging the batteries.</p>	 <p>Indicates the locking / unlocking of the robot wheels to be able to move it manually.</p>	 <p>Indicates the correct direction of the reel according to the adhesion side of the film.</p>
---	--	--	--





### 4.4.3 Arrangement of safety signs



## 4.5 Setting up and handling of the machine

To install the robot post, proceed as follows:

1. Use a crane or forklift (Fig. 1.8) to transport the machine without its packaging to the installation site.
2. If you are using a forklift, make sure you insert the forks correctly in the appropriate inlets on the side of the robot (Fig. 1.8 A).
3. Attach a rope to the M10 eyebolt in the upper part of the column (Fig. 1.9) and slowly lift it until it reaches the 90 ° position with respect to the plane (Fig. 1.10).
4. Insert the 3 screws supplied to fix the column to the robot structure (see Fig.1.11)

FIG. 1.8



FIG. 1.8 A

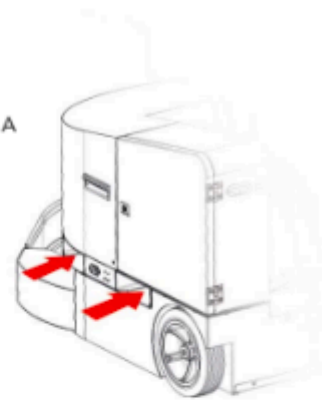


FIG. 1.9



FIG. 1.10

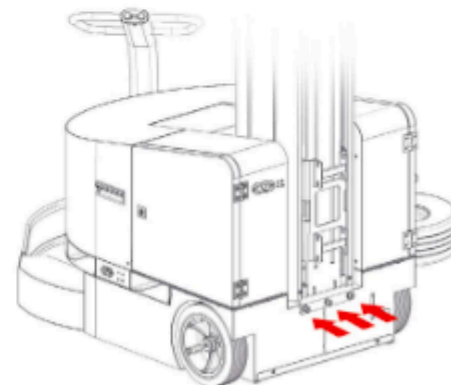
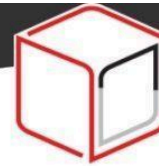


FIG. 1.11



## 4.6 Control panel



FIG. 1.12

For control panel functions, refer to Fig.1.12

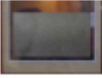





-  **COLOR TOUCH SCREEN PANEL** 1
-  **BATTERY LEVEL:**  
Indicates the battery charge level of the robot 2
-  **RESET BUTTON**  
Push it for 3/4 resets the machine in case of errors 3
-  **ROBOT KINDLING SYSTEM** 4
-  **GREEN BUTTON: START button**  
**WHITE LIGHT ON: Machine in motion**  
**RED BUTTON: STOP button** 5
-  **EMERGENCY BUTTON** 6



FIG. 1.13



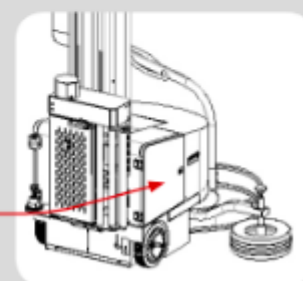
### ATTENTION

Before activating the robot ignition system, ROBO WRAP 600A and 600B, check that the magnetothermal switch is positioned upwards. Otherwise the machine will not be electrically powered making it unusable. FIG. 1:13

The magnetothermal switch is located inside the left electrical compartment of the robot.

FIG. 1.14

FIG. 1.14



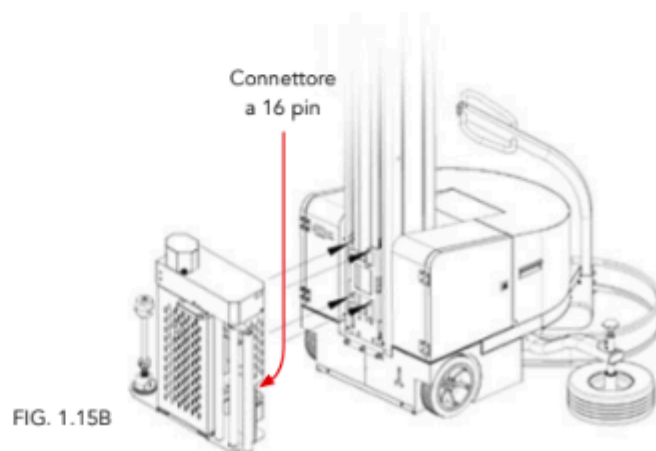
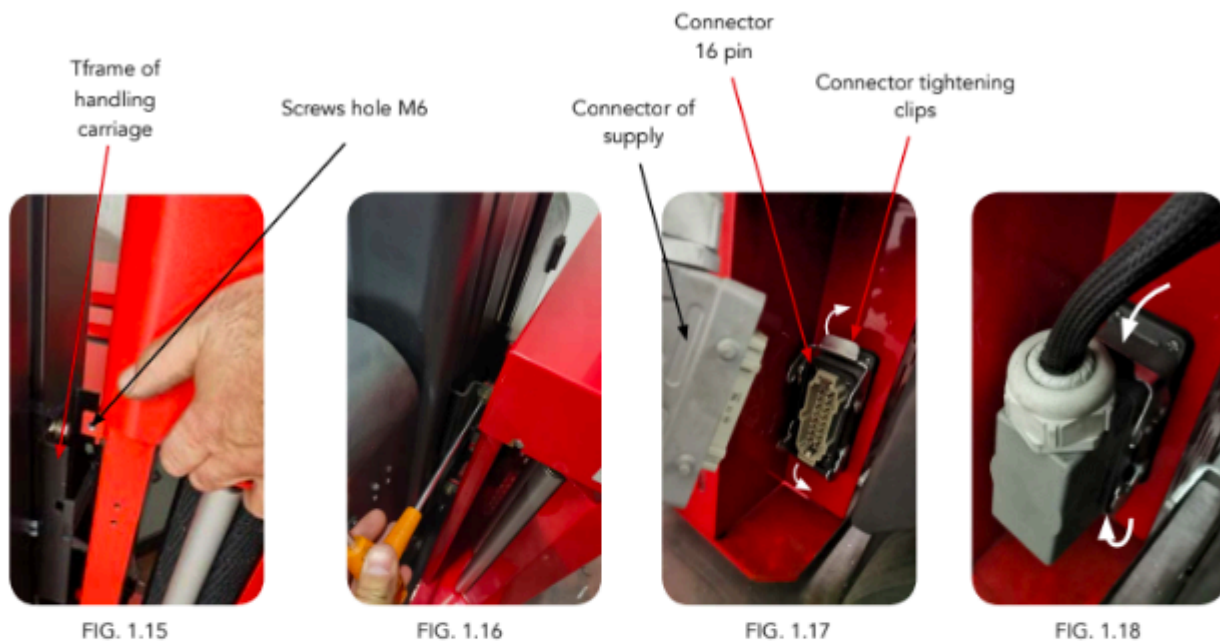
If the battery level is low when first switched on, put the robot on charge for at least 8 hours.

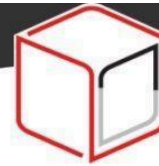


## 4.7 STEP ROBOT PALLET WRAPPER 300% carriage installation with motorized pre-stretch

If you have purchased the STEP ROBOT PALLET WRAPPER 300% model and the film reel carriage is removed from the machine, proceed according to the following instructions.

1. Lift the trolley and place it in the special couplings on the handling frame located on the robot column (FIG. 1.15 - FIG. 1.15A);
2. Use the 4 M6 screws to fix the trolley to the handling frame (FIG.1.15B);
3. Tighten the 4 M6 Allen screws, (Fig. 1.16);
4. Insert the power connector into the appropriate 16-pin socket located in the side base of the trolley. Be careful in checking that the 2 fastening clips of the connector are positioned upwards (FIG. 1.17).
5. Lock the connector by lowering the 2 locking clips (FIG.1.18).





### 4.7.1 Film reel loading system (only for STEP ROBOT PALLET WRAPPER 300%)

1. Insert the reel on the carriage rod as indicated in Fig.1.16
2. Make sure that the coil is well positioned. FIG. 1.17
3. Open the door and pass the film as shown in FIG. 1.18
4. Close the door and pass the film as shown in FIG 1.19



#### IMPORTANT

Before passing the film into the carriage, check the adhesion part of the film, whether internal or external. In the example below, the adhesion part is located on the inside. If external, follow the instructions in FIG. 1.20

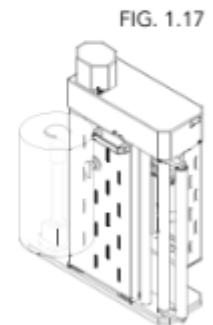
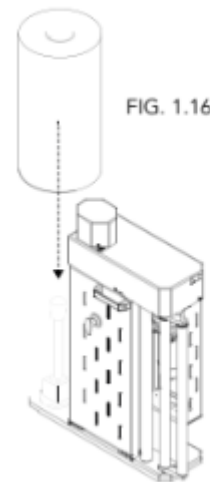


FIG. 1.18



FIG. 1.19

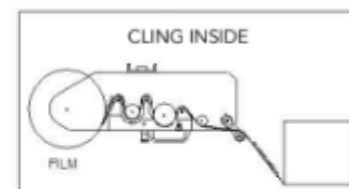
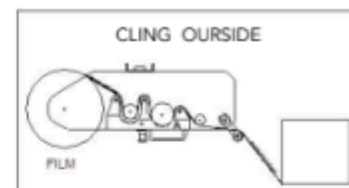
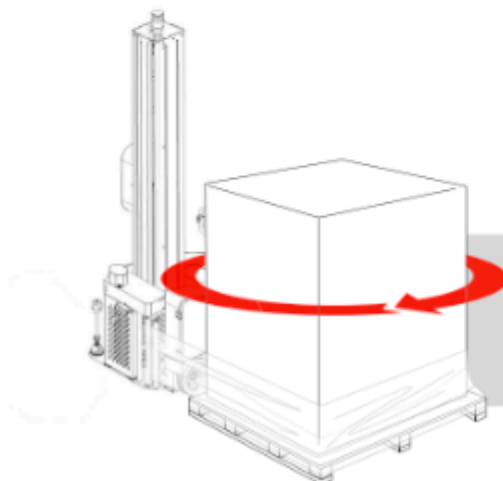


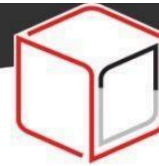
FIG. 1.20



#### DIRECTION OF ROTATION OF THE ROBOT

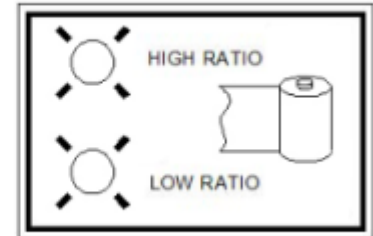
The correct assembly of the film reel is very important to obtain a perfect adherence to the packaging to be wrapped.





### PRE-STRETCH INDICATOR

In the front part of the trolley there are 2 luminis LEDs that indicate the degree of pressure that is being used 300% and 230%. When the led is lit on HIGH RATIO it indicates that a pre-stretch of the film at 300% is being used, while when the led on LOW RATIO is lit it is set at 230%. (250% and 200% optional)



## 4.8 Carriage installation with manual film tensioning (STEP ROBOT PALLET WRAPPER BRAKE)

If you have purchased the **STEP ROBOT PALLET WRAPPER BRAKE** model and the film reel carriage is removed from the machine, proceed according to the following instructions.

1. Lift the trolley and place it in the special couplings on the handling frame located on the robot column (Fig 1.21);
2. Use 4 M6 Allen screws to fix the trolley to the handling frame and tighten them (Fig 1.22);
3. Screw the trolley elevation electrical connector into the appropriate socket, as shown in Fig. 1.23
4. Once the connector has been screwed, secure it to the frame with a plastic clamp as shown in FIG. 1.24



FIG. 1.21



FIG. 1.22



FIG. 1.23

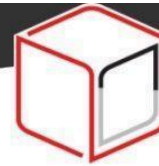


FIG. 1.24

### 4.8.1 Film reel loading system (for STEP ROBOT PALLET WRAPPER BRAKE)

1. Insert the reel into the carriage rod as shown in Fig. 1.25
2. Respect the direction of insertion of the film as shown in Fig.1.26 - 1.27 (film with internal adhesion)
3. Pass the film through the rollers of the carriage as shown in the diagram of FIG. 1.28





REEL HOLDER ROD



FIG. 1.25



FIG. 1.26



FIG. 1.27

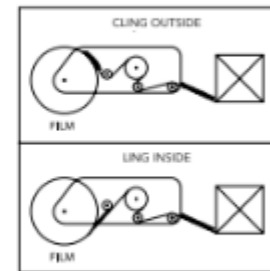


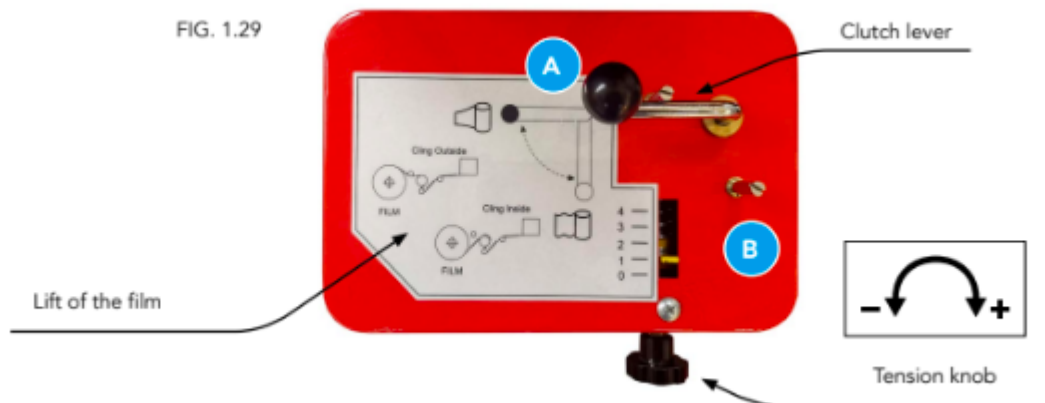
FIG. 1.28

## 4.8.2 Film lift system

Once the film reel has been inserted, proceed as follows:

1. Place the film clutch lever in position "B" (FIG.1.29)
2. According to the type of reel purchased, carry out the passage of the film as described in FIG. 1.28 (PAGE 19)
3. Once the film has passed between the rollers, pull it and let it come out for about 1 meter FIG 1.27 (PAGE 19)
4. Reposition the clutch lever in position "A" (FIG.1.29)
5. According to the type of film tensioning desired, turn the tensioning knob clockwise or counterclockwise (FIG.1.29). Turning the knob will indicate the degree of tension of the film ranging from a value of 0 to 4.

FIG. 1.29



## 4.9 Battery charging and rules for their use

When starting the machine for the first time, check the battery level on the indicator (FIG. 1.30) located on the control panel. If it is discharged, charge it for at least 8 hours or until the full charge LED lights up.

The battery charging phases are indicated by two LEDs. If in YELLOW color (FIG. 1.31) it indicates that the battery is charging, if in GREEN color (FIG. 1.32) it indicates that battery charging is completed. If the machine is not equipped with external LEDs, refer to the LEDs located on the internal battery charger (FIG. 1.33).





FIG. 1.30



FIG. 1.31



FIG. 1.32



FIG. 1.33

If you intend not to use the robot for a long time, you must disconnect the batteries to avoid the self-discharge phenomenon which can lead to sulfation of the batteries making them unusable. To do this, simply set the magnetothermal switch to OFF (see page 18 FIG. 1.13). This switch is located in the left door of the machine where the charger is housed.

It is advisable to recharge the batteries before they are completely discharged, it is very important that once they have been charged, the entire charging cycle is completed. Consider that the average life of batteries with AGM technology is 300/400 cycles but can reach 1200 cycles respecting the optimal conditions of use with a maximum operating temperature of 20 ° C. Therefore,

with daily cyclic use, based on the depth of discharge and the conditions described above, the batteries may run out even within the year of life.

A working temperature above 20 ° C considerably reduces the life expectancy of the batteries, with a 50% reduction in life for every 10 ° C of temperature increase.

The batteries must never discharge over 80% and their voltage (per single battery) must never be less than 10.8 Volts.

Batteries should never be recharged with a load connected (with the machine switched on).

The one-year legal warranty provided for AGM batteries is not valid for cyclical ones, where the battery life is not in years, but in number of life cycles.

The law establishes that the production and / or conformity defect is given as such if it occurs within the first six months of purchase, after this period it is necessary to verify by testing the battery if it is a manufacturing or maintenance defect or other or if

the battery has exhausted its number of life cycles.



**WARNING**

The battery contains sulfuric acid. Care must be taken when manipulated. In case of accidental contact with acid, do not touch your eyes or mouth. Wash immediately with running water. Go to the hospital emergency room.

Disposal: the batteries must be disposed of according to the regulations in force.

#### 4.10 Robot handling by means of the drawbar

If you want to move the robot manually, loosen the tension spring of the rudder by moving the latter towards the outside

(A) FIG. 1.33 and FIG. 1.34. To tighten and hold it in place, move it slightly to the right (B). To restore the rudder voltage, proceed by carrying out the reverse operation.




**IMPORTANT**  
Before starting the robot for the duty cycle be sure provided that the rudder spring is under tension.

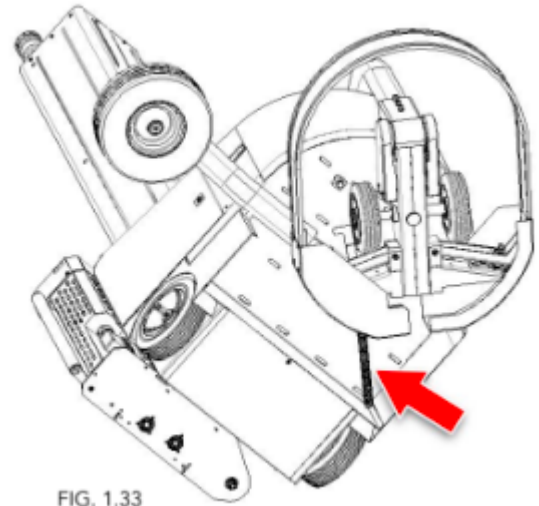


FIG. 1.33

#### 4.10.1 Robot handling by means of the drawbar

In the center of the rudder handle there are two buttons (FIG 1.35) that allow you to electrically move the robot forward or backward. holding down button A the robot goes forward, while pressing button B goes back.

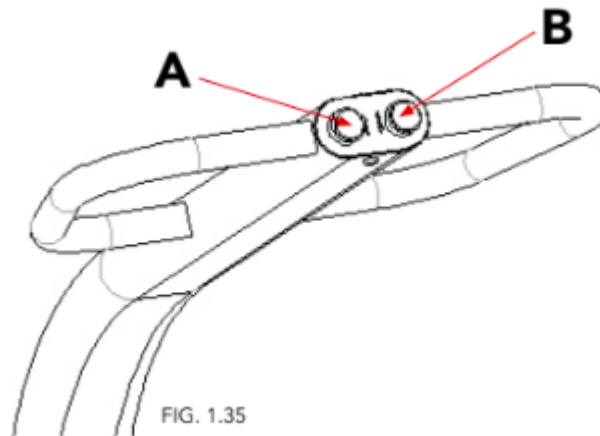
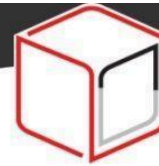
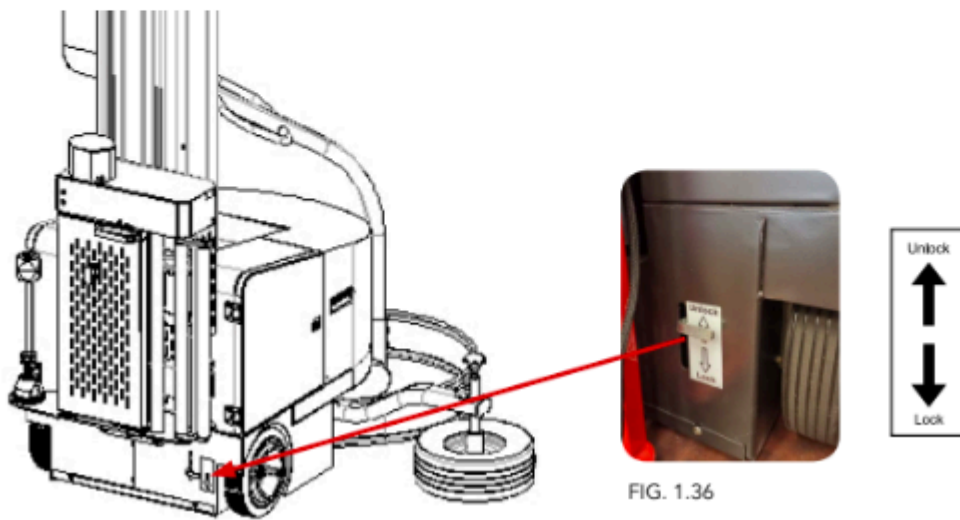


FIG. 1.35



**IMPORTANT**

1. To use controls A and B, the engine clutch brake must be in the "Lock" position. (See FIG 1.36.)
2. During the winding cycle, the motor clutch brake must be in the "Lock" position.
3. When the battery is low or the power supply is cut off by pressing the emergency switch, release the motor clutch brake to move the robot. (FIG 1.36).



### 4.11 Installation and adjustment of the feeler wheel

By opening the packaging of the robot you will find a feeler wheel to be installed on the machine. This is essential for the machine to carry out the pallet wrapping procedure. Without this the machine will not be able to carry out any work cycle.



1 Unscrew the three M8 screws



2 Insert the feeler wheel frame



3 Screw and tighten the three M8 screws



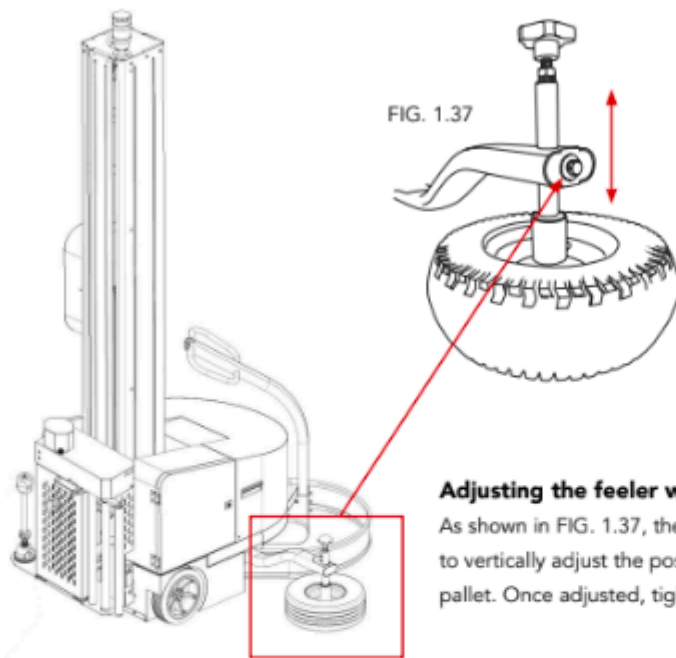


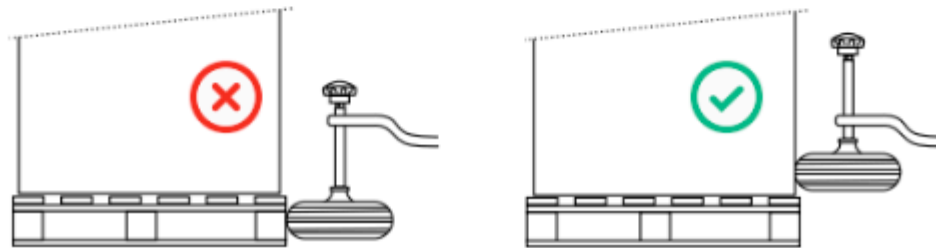
FIG. 1.37

### Wheel pressure

Inside the packaging, the feeler wheel is supplied from the factory at a pressure of 2 bar. If it is deflated, restore pressure.

### Adjusting the feeler wheel

As shown in FIG. 1.37, there is an M8 fixing screw, which allows (by loosening it) to vertically adjust the position of the feeler wheel against the lower part of the pallet. Once adjusted, tighten to maintain the setting.



## 4.12 Machine start-up via control panel

1. The operator's working position must be lateral to the robot as shown in Fig. 1.35
2. Turn the main switch clockwise to "ON" (Fig. 1.36 POS. 4);
3. Check the battery charge level (FIG 1.36 POS. 2). In case of insufficient energy, recharge the battery.
4. In case the machine goes into emergency, make sure that the emergency button is not activated (Fig. 1.36 POS. 6). In this case, turn it clockwise to turn it off.
5. After switching on, if the robot has errors on the display, identify the problem from the error card (PAG 34) and then, having solved the problem, press for 3/4 sec. the Reset button (Fig. 1.36 - Pos. 3) making the machine ready for work.
6. Select the work cycle from the display and press the START key on the control panel (Fig. 1.36 POS. 5) to operate the robot.



FIG. 1.35




FIG. 1.36



#### REMOTE CONTROL

An additional option present only in the Robo Wrap 600B model is to have a remote control for operating the machine from a distance.

### 4.12.1 > Use of the robot in manual mode

To use the robot in manual mode, press the icon  on the touch screen interface to access the management menu. Fig.1.37 refers to the STEP ROBOT PALLET WRAPPER BRAKE model while Fig.1.38 refers to the STEP ROBOT PALLET WRAPPER 300%

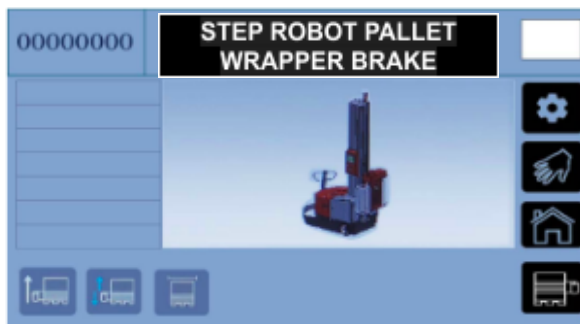


FIG. 1.37

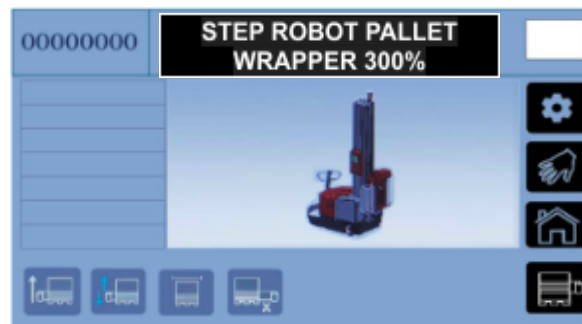









FIG. 1.38

In the screens shown below, it is possible to manage the trolley elevation by pressing the icon , and the trolley lowering by pressing the icon . To return to the main menu, press the icon .

#### 4.16 > Automatic work cycle

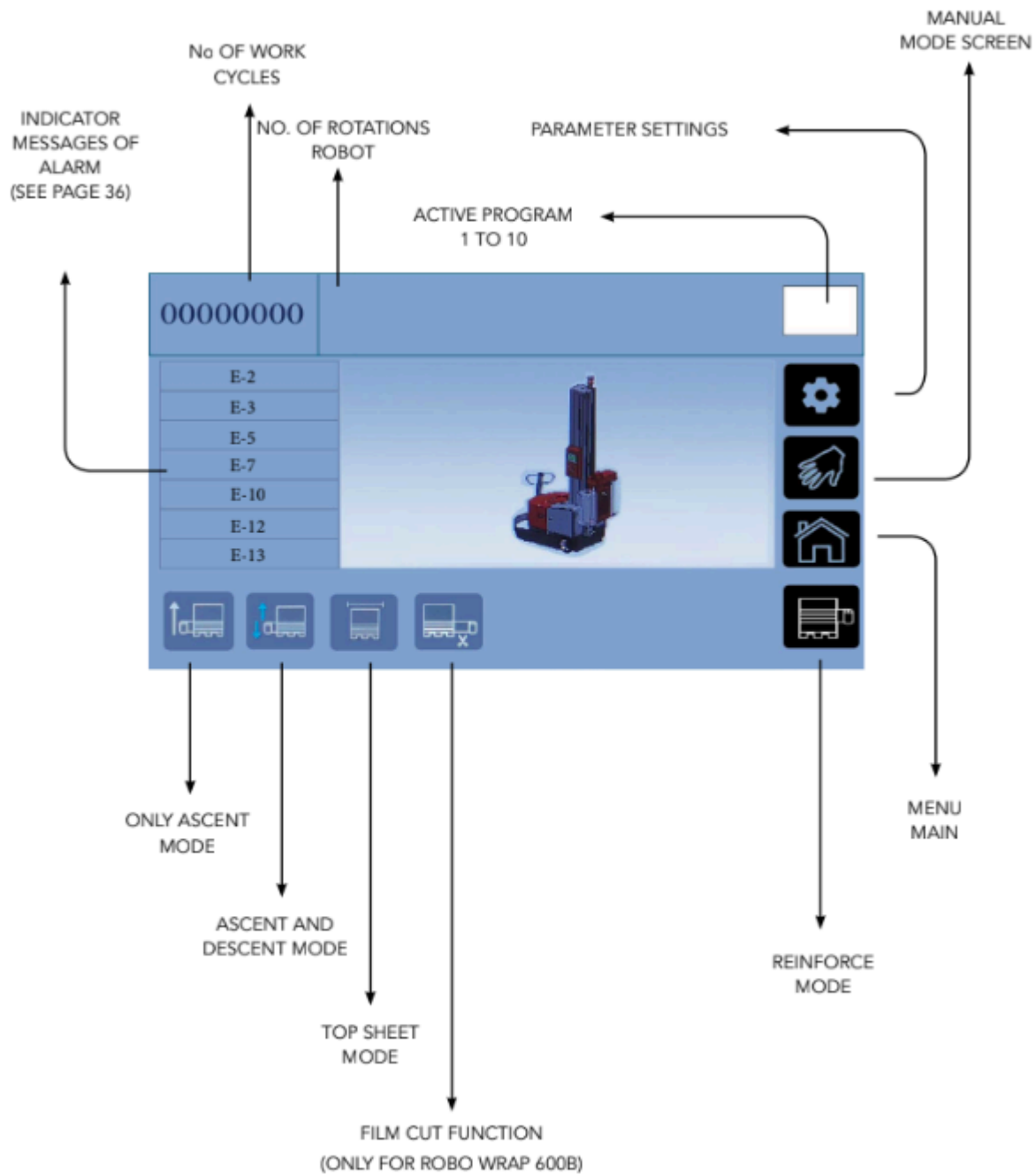
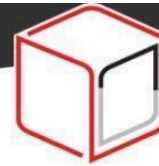
Access the parameter setting screen using the icon  from the display home. Select the desired program number, adjust the number of high and low turns of the film by entering the parameter next to the icon  and the number of corners of the object to be wrapped . Reposition on the main screen using the icon . Check that the pallet to be wrapped does not exceed a height greater than the values allowed by the robot. Press the START key to start the work cycle.



## 5. DESCRIPTION AND FUNCTIONS OF THE TOUCH PANEL

### 5.1 System startup

After starting the machine, the system presents the robot icon in the center of the screen. By clicking on it you will enter the MENU settings: as shown below.



## 5.2 Work parameters setting

To manage the program settings on the robot, follow the steps below:

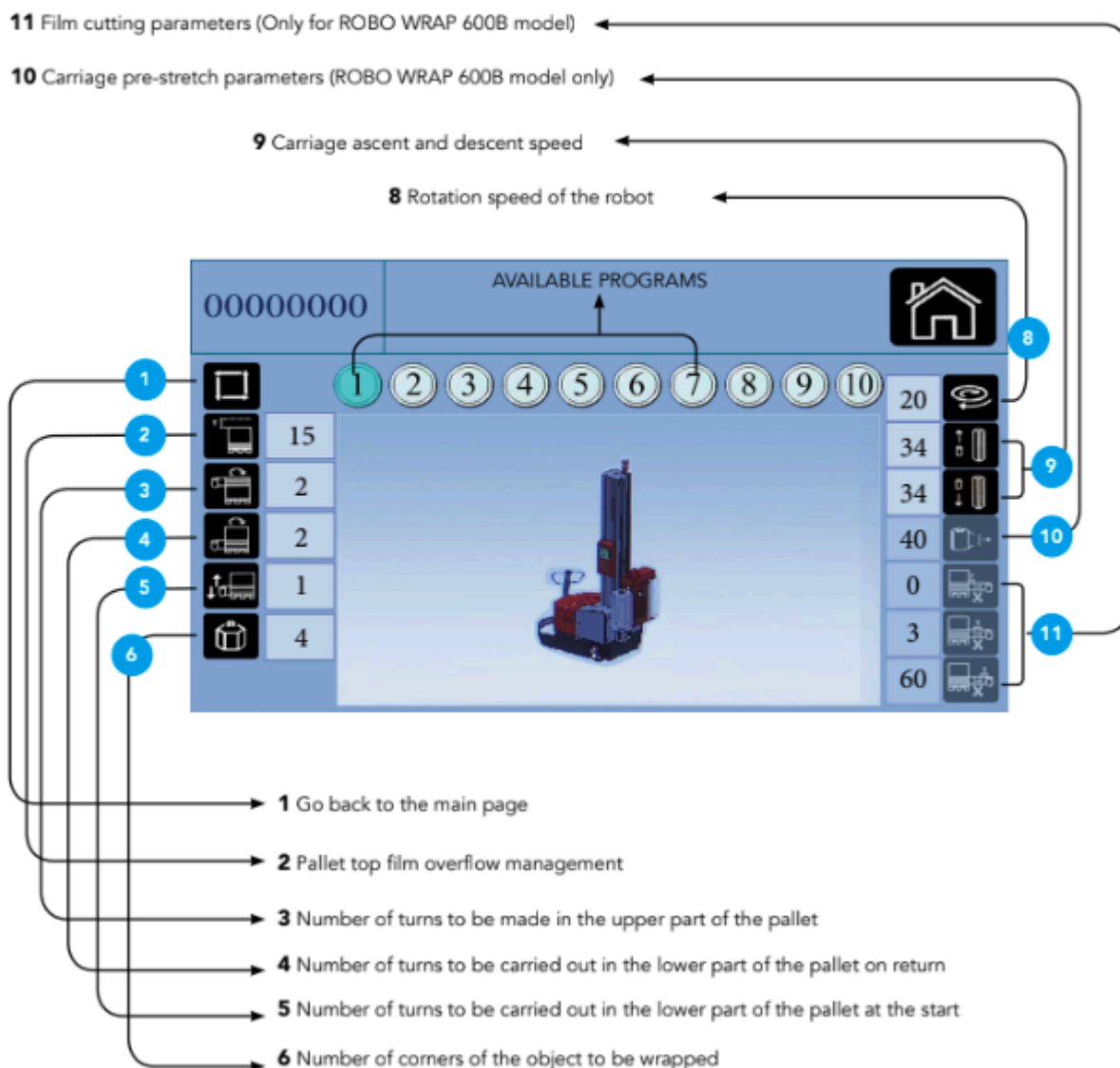
- Click on the active program number on the main page



- In the screen proposed it is possible to parameterize the settings of the functions listed below.
- To manage the parameters, click on the number at the top of the icon to open the numeric data entry keypad.
- Once the desired changes have been made, return to the main page and start the machine work cycle.



The parameters shown in the screen below are the basic factory settings configured when the machine is delivered.

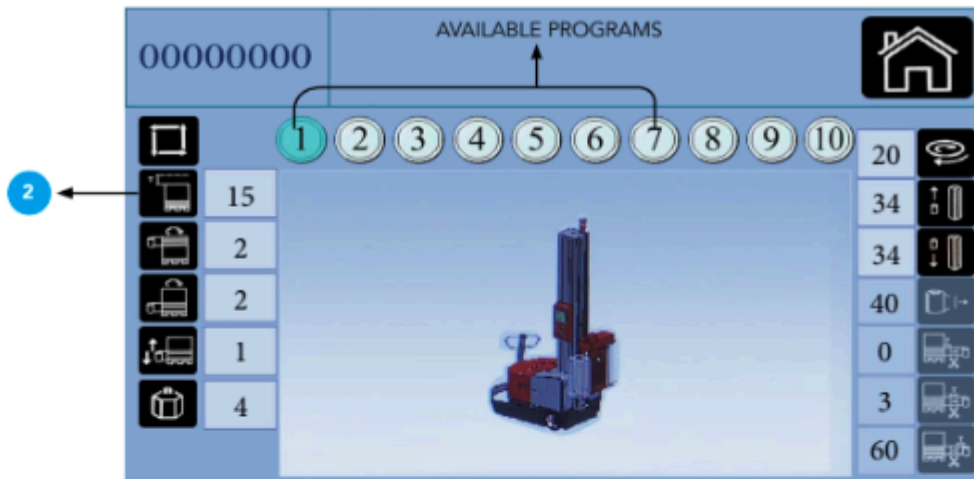


### 5.3 Setting of film edge and altimeter for carriage

NB.: From program 1 to 7 (FIG. 5.1) it is possible to set the film edge parameters to be applied in the upper part of the

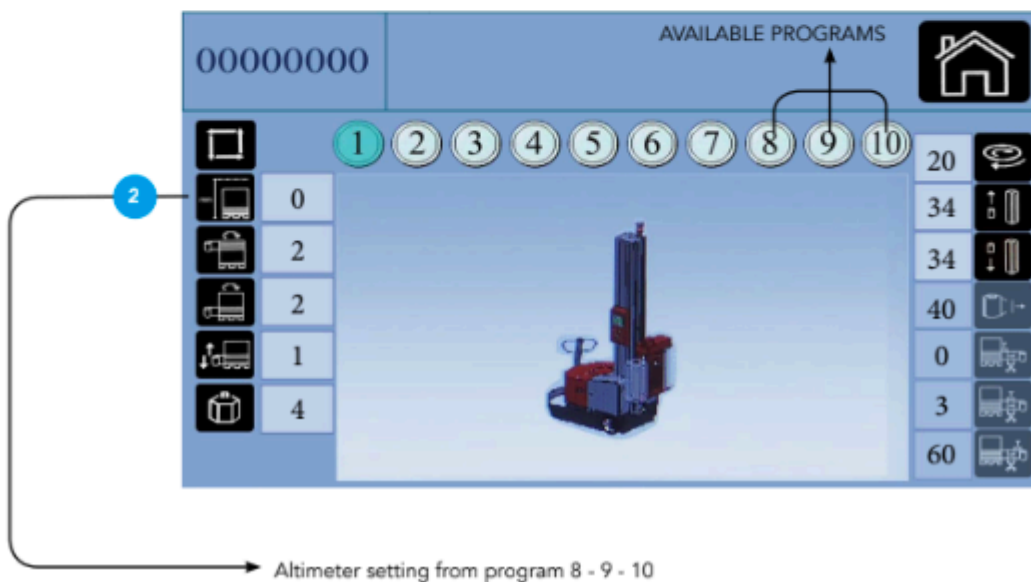
pallet. From program 8 - 9 - 10 the icon (2) shown in FIG. 5.2 it is possible to set the cart altimeter option by isolating the photocell reading.

FIG. 5.1



The altimeter setting parameters are factory set to "0" because it is a value to be defined according to the customer's needs.

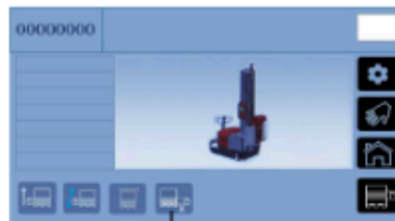
FIG. 5.2



## 5.4 Manual operation of the machine

To use the machine in manual mode, press the icon  on the main machine start page (Fig. 5.3). Pressing the icons presented in Fig.5.4 will perform the following actions:

FIG. 5.3



ONLY ROBO WRAP 600B

PAGE  
MAIN

ASCENT AND DESCENT OF  
THE CARRIAGE

MANUAL FUNCTION SCREEN



BACK TO  
MAIN PAGE



FIG. 5.4

## 5.5 Reinforce mode

In both robot models there is the reinforcement cycle function which allows to increase the film turns to be applied to a preset height of the pallet. To manage this function, click on the icon shown in Fig. 5.5



FIG. 5.5

The screen that will open will be the one shown in Fig. 5.6. By clicking on the icons   in (Fig. 5.6) you can set the height on which to carry out the reinforcement cycle on the pallet. In box “C” the height in mm will be shown in real time. By clicking on the “Save Settings” icon, the parameter will be saved in the “D” field. To complete the operation, just click on the “E” field to enter the number of reinforcement cycles to be performed by the robot. From the numeric keypad that will appear (FIG. 5.7) enter the numeric value and click on the ENTER key to confirm. Return to the main page and start the work cycle.

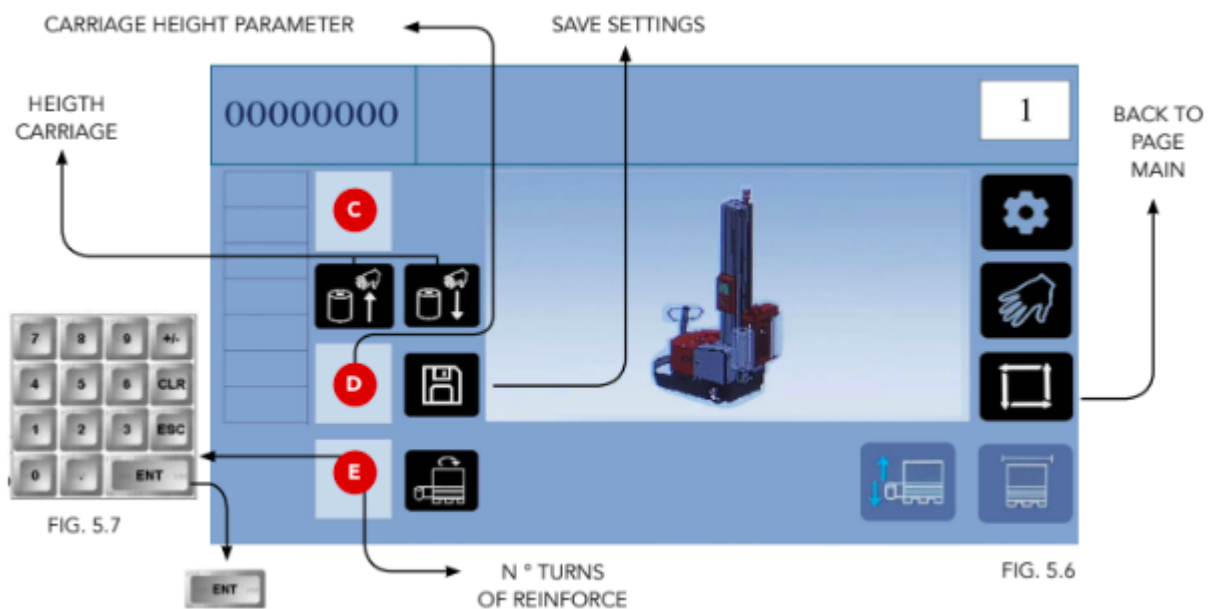


FIG. 5.7

FIG. 5.6

## 5.6 Top Sheet mode

To manage the sheet feeder function when wrapping products, click on the icon shown in figure 5.7. By clicking on it, the

icon will switch to the status highlighted in light blue.

**Action performed by the machine using this function**

By push the START key from the control panel, this will start the pallet wrapping cycle, stopping automatically in the upper part of the pallet. Once the operator has performed the manual insertion of the top sheet, he will have to press the START button again to restore the activation of the machine which will end the work cycle.

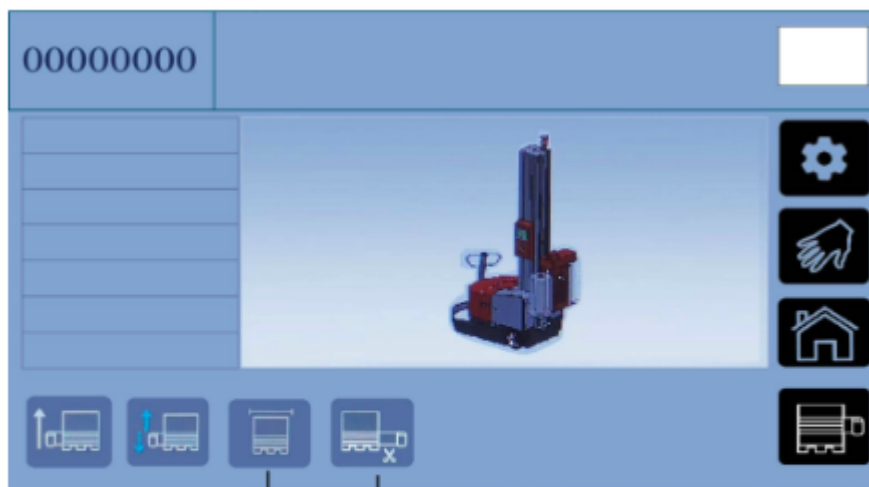


FIG. 5.8

TOP SHEET

FUNCTION PRESENT ONLY IN ROBO WRAP MODEL 600B

**5.7 Only ascent mode**



ASCENT ONLY CYCLE

FIG. 5.9

To manage the upward winding function, click on the icon shown in figure 5.9. By clicking on it, the icon will switch to the status highlighted in light blue.

**Action performed by the machine using this function**

By pressing the START key from the machine control panel, this will start the wrapping cycle by completing the work cycle in the upper part of the pallet.

### 5.8 Automatic film cutting

The automatic film cutting option is present only for the STEP ROBOT PALLET WRAPPER 300% model. Using the icon on the display (FIG. 5.10) you can activate or deactivate this option.

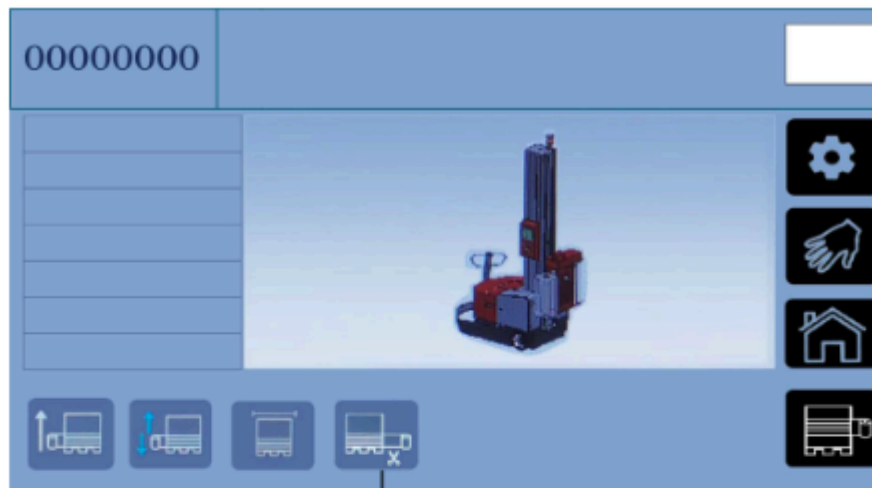


FIG. 5.10

AUTOMATIC FILM CUTTING



#### IMPORTANT

From the settings menu it is recommended not to alter the factory configuration parameters. This could lead to incorrect operation of the cutting system.

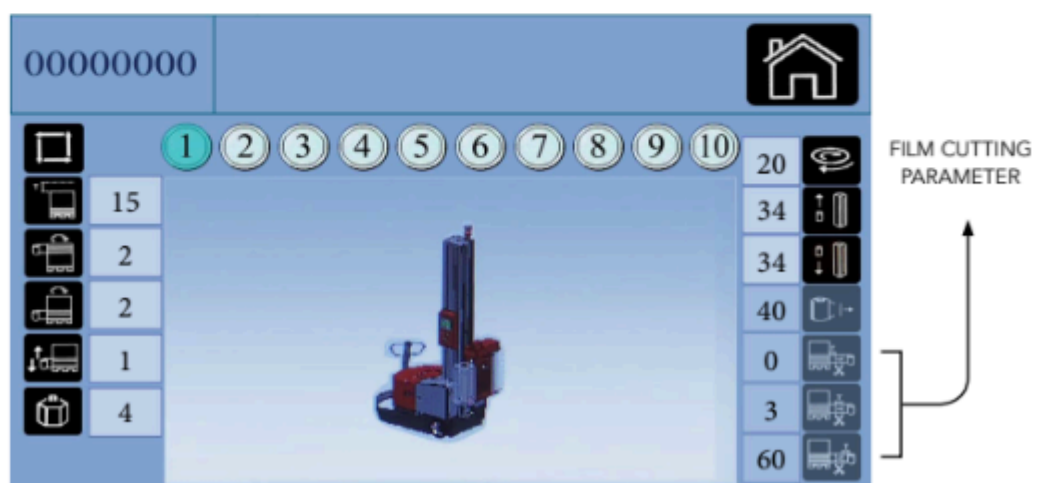


FIG. 5.11



## 6. MACHINE ERRORS

### 6.1 Carriage

The carriage cannot move upwards: the proximity sensor at the machine corner has an anomaly.

Solution: Make sure the angled proximity sensor is functional. If necessary, check all wiring and connections. Adjust the angle of the proximity switch.

### 6.2 Charging the battery

After 8 hours of charging, the battery does not increase its charge level. Symptom: The problem lies in charging the battery.

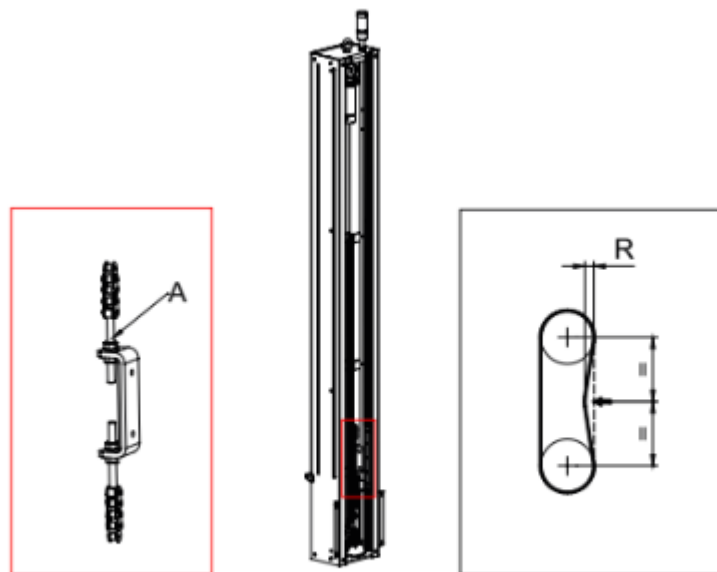
Solution: check if the battery charger or the wire connection are working properly.

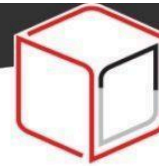
After 8 hours of charging, the battery cannot be restored (charged). Symptom: The battery cannot be recharged.

Solution: replace the battery.

### 6.3 Reel holder carriage lifting chain

If you notice noises when lifting the bobbin holder, it could be due to excessive tensioning of the chain. Adjust the chain inside the column as follows: Remove the side cover of the column, adjust with the screw (A) so that the chain (R), pulling it by hand, has a slack of  $10 \div 15$  mm. replace the cover on the column and tighten the screws.



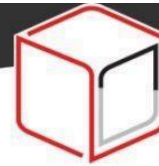


## 6.4 Alarms

If the machine stops during operation, the touch display indicates the alarm number (E-x), the meaning of which is expressed in the following table. Fixed the problem hold down the REST key located on the control panel for 3/4 sec.

ALARM N°	ANOMALY	CAUSE
E-2	LOW VOLTAGE	<ol style="list-style-type: none"><li>1. Check the voltage.</li><li>2. Faulty power supply circuit.</li></ol>
E-3	ANOMALIES OF THE EMERGENCY SIGNAL	<ol style="list-style-type: none"><li>3. Check if the emergency button has been pressed</li><li>4. The BUMPER protection system may have activated.</li><li>5. Entrance door of the pre-stretch carriage open.</li><li>6. Anomalies of the emergency proximity circuit, of the BUMPER protection system, of the entrance door of the reel-pruning carriage.</li><li>7. Anomaly of the relay.</li></ol>
E-4	PROBLEM WITH THE ENGINE OR THE ELECTRICAL SYSTEM OF THE CART	<ol style="list-style-type: none"><li>8. Power interruption to the reel holder carriage</li><li>9. Check the signal of the proximity sensor of the reel holder carriage or circuit anomalies</li></ol>
E-5	MOTOR FAULT CARRIAGE PRE-STRETCH	<ol style="list-style-type: none"><li>10. Check the electrical voltage to the pre-stretch carriage motor.</li><li>11. Low electrical voltage.</li><li>12. Absence of enable signal.</li><li>13. Anomaly of the emergency signal.</li></ol>
E-6	MOTOR FAULT OF HANDLING	<ol style="list-style-type: none"><li>14. Check the electrical voltage of the handling motor</li><li>15. Low electrical voltage.</li><li>16. Lack of enable signal.</li><li>17. Anomaly of the emergency signal.</li></ol>
E-7	ANOMALY IN THE HANDLING OF THE ASCENT / DESCENT OF CARRIAGE	<ol style="list-style-type: none"><li>18. Electric voltage problem in the handling motor</li><li>19. Low electrical voltage.</li><li>20. Lack of enable signal.</li><li>21. Emergency button activated.</li></ol>





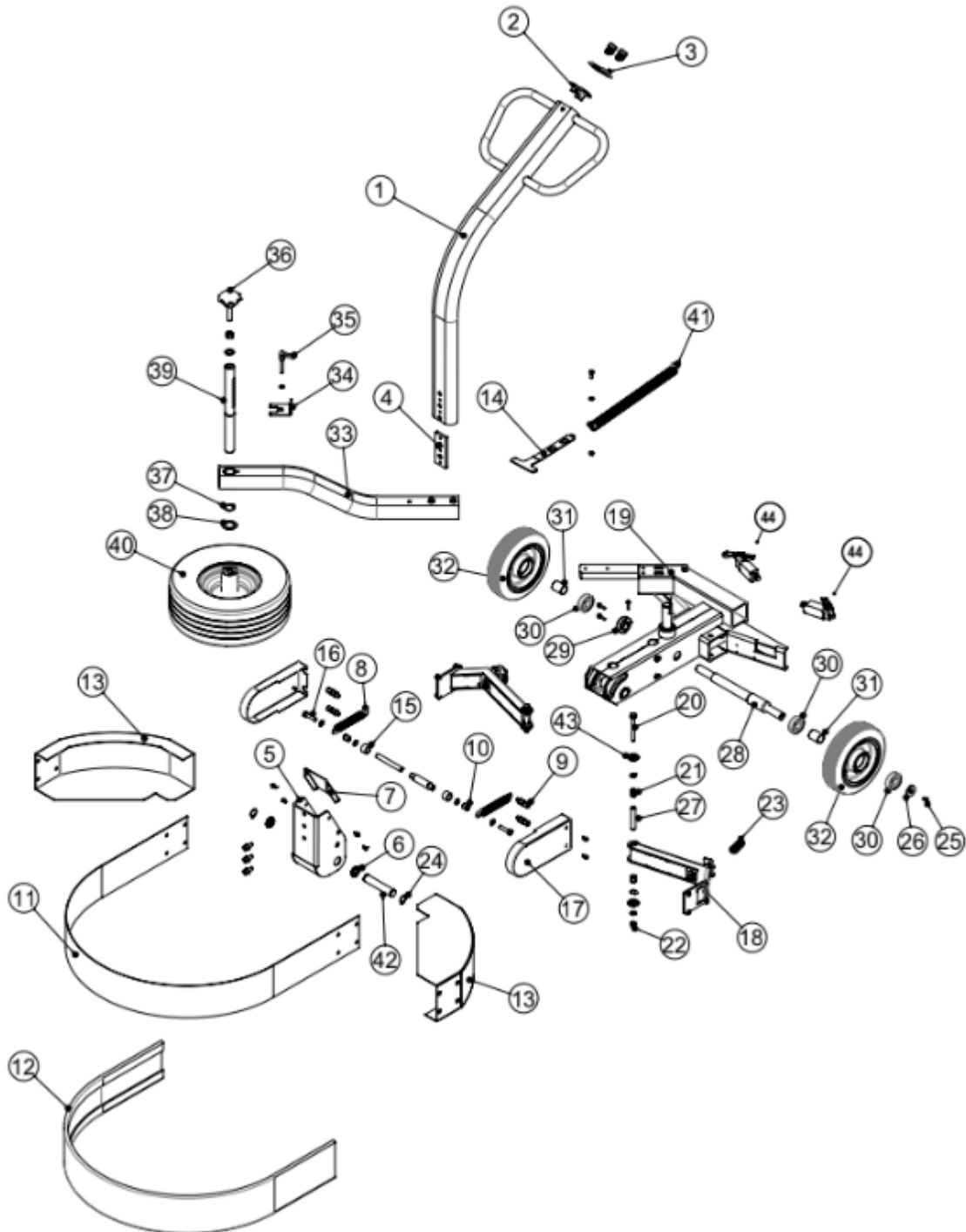
ALARM N°	ANOMALY	CAUSE
E-8	THE PHOTOCELL OF READING DOES NOT FIND ITEM (GOODS)	<ol style="list-style-type: none"><li>1. The photocell does not find the object (goods on pallets) at start-up.</li><li>2. Faulty photocell or failure of its circuit.</li></ol>
E-9	THE CARRIAGE IS NOT IN LOCATION OF ORIGIN (ZERO POSITION).	Failure of the carriage in its descent path or anomaly of the trolley circuit.
E-10	AUTOMATIC WORK (MANUAL WORK)	
E-12	WORKING MODE NOT SELECTED (AT START)	
E-13	THE BRAKE IS OPEN. (SEE PAGE 24)	<ol style="list-style-type: none"><li>3. The engine clutch brake is open UNLOCK.</li><li>4. The manual brake mechanism is open.</li><li>5. Circuit failure or fault in the brake proximity sensor</li></ol>

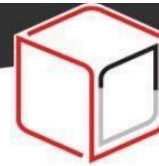




## 7. PART LIST

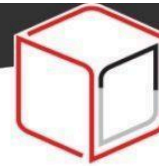
### 7.1 Control lever unit





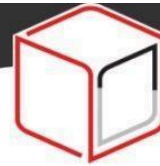
No	PART No	DESCRIPTION	QTY
1	FGP603000200000010	Control lever	1
2	FGP603000900000010	Cover	1
3	FGP603000800000012	Cover plate	1
4	FGP603001000000010	Clamping plate	1
5	FGP603000500000000	Support base	1
6	FGP603002900000005	Sleeve	2
7	FGP603000600000000	Cover	1
8	FGP60WG02600000000	Spring	2
9	FGP603002100000000	Stud	4
10	FGP603002000000000	Suspending sleeve	2
11	FGP603001700000000	Safety bumper	1
12	FGP603001700000008	Rubber guard bar	1
13	FGP603001800000000	Holding plate	2
14	FGP603001200000002	Spring holding plate	1
15	FGP603002500000000	Absorbing collar	2
16	1010082500000000000	Hex bolt M8×25L	2
17	FGP603001600000000	Cover	2
18	FGP603000100000000	Rotating arm	2
19	FGP603000000000010	Lever base weldment	1
20	1011087000000000000	Hex bolt M8×70L	2
21	FGP603003000000005	Sleeve	4
22	1033080000000000000	Nut m8	2



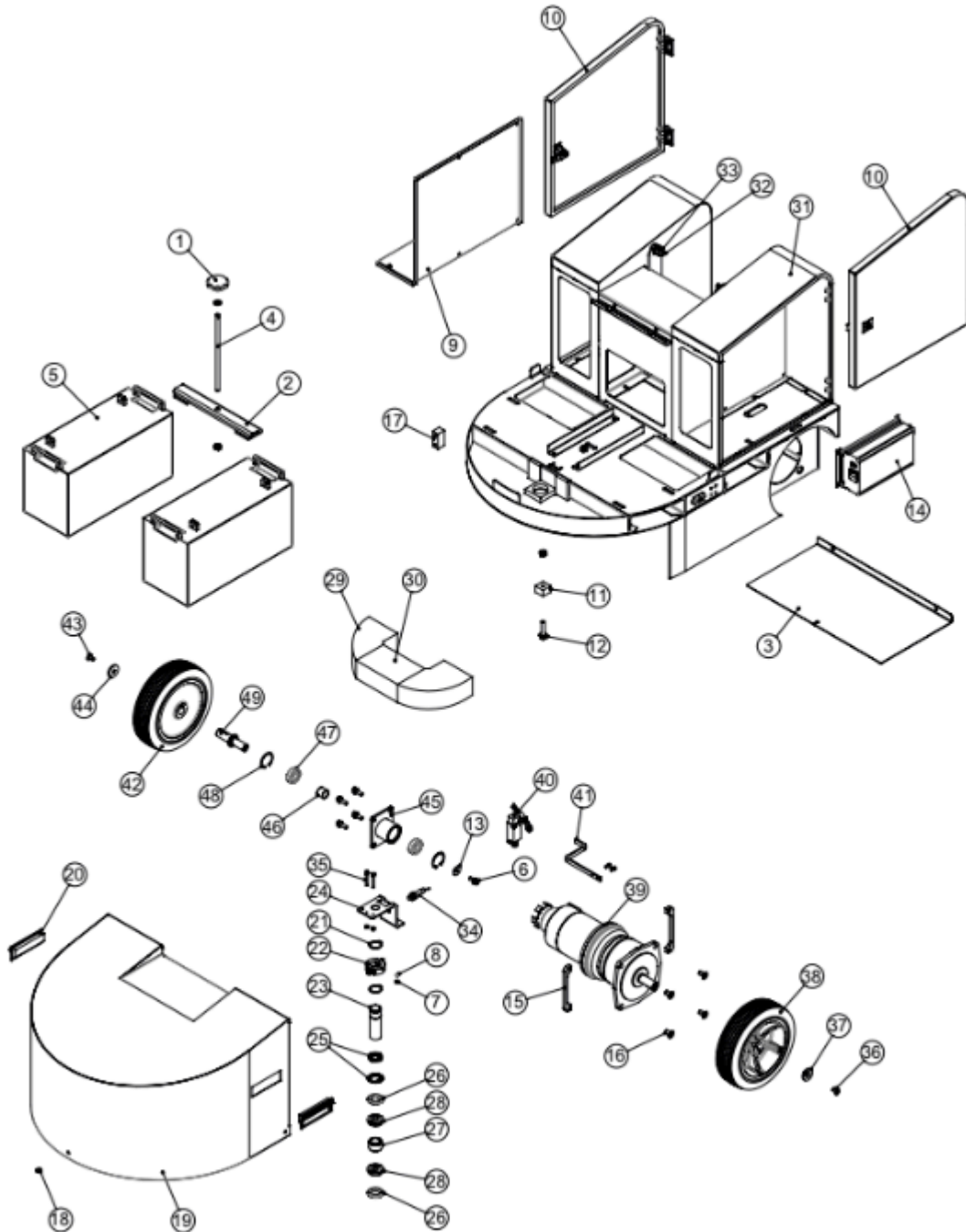


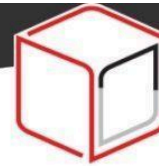
23	FGP60WG00700000000	Spring	1
24	113020000000000000	C-clip s-20	2
25	101406160000000000	Hex bolt M6×16L	2
26	FGP603001100000000	Washer	2
27	FGP603003100000000	Tube	2
28	FGP603002600000000	Tyre axle shaft (front)	1
29	FGP603002800000000	Fixing ring	1
30	303020400000000000	Bearing 6204zz	4
31	FGP603002700000000	Collar	2
32	FGP603003200000003	Tyer (front)	2
33	FGP603004000000010	Arm	1
34	FGP603001400000002	Fixed plate	1
35	FGP60WG00400000000	Handle (m6×45l)	1
36	FGP60WG00600000000	Knob m12×55l	1
37	113025000000000000	C-clip s-25	2
38	FGP603001500000002	Washer	2
39	FGP603001900000000	Guild roller shaft	1
	FGP60WG00901000000	Tyre, steel core	1
40	FGP60WG00902000000	Tyre, cover	1
	FGP60WG00903000000	Tyre, inner tube	1
41	FGP60WG00800000000	Spring	1
42	FGP603002200000000	Shaft	1
43	FGP60WG00300000000	Bearing ax1528	4
44	FGP60WG02000000000	Limit switch (d4v-8108sz)	2





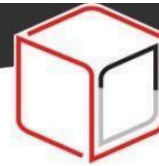
## 7.2 Body





No	PART No	DESCRIPTION	QTY
1	FGP60WG02800000000	Knob m12	1
2	FGP602000400000010	Battery hold-down strip	1
3	FGP602000500000010	Motor cover	1
4	FGP602003200000000	Screw	1
5	FGP60WG01200000000	Battery (12v-120ah)	2
6	1025082000000000000	Screw m8×20	1
7	FGP60WG01300000000	Spring	3
8	9140080600000000000	Ball	3
9	FGP601000300000010	Wiring plate	1
10	FGP601000100000010	Electrical box door (rh/lh)	2
11	FGP602002800000000	Buffer block	1
12	1011104500000000000	Screw m10×45l	1
13	FGP602000700000000	Washer	1
14	FGP60WG00100000000	Electrical charger	1
15	FGP602001000000000	Bracket	2
16	1014103000000000000	Countersink screw m10×30l	4
17	FGP602002700000000	Buffer block	1
18	1017051000000000000	Screw m5	3
19	FGP6020006000000030	Cabinets cover	1
20	FGP60WG01000000004	Handle	2
21	1130300000000000000	C-clip s-30	1
22	FGP6020022000000006	Collar	1
23	FGP602002300000000	Sleeve	1
24	FGP602000300000000	Prox. Switch seat	1



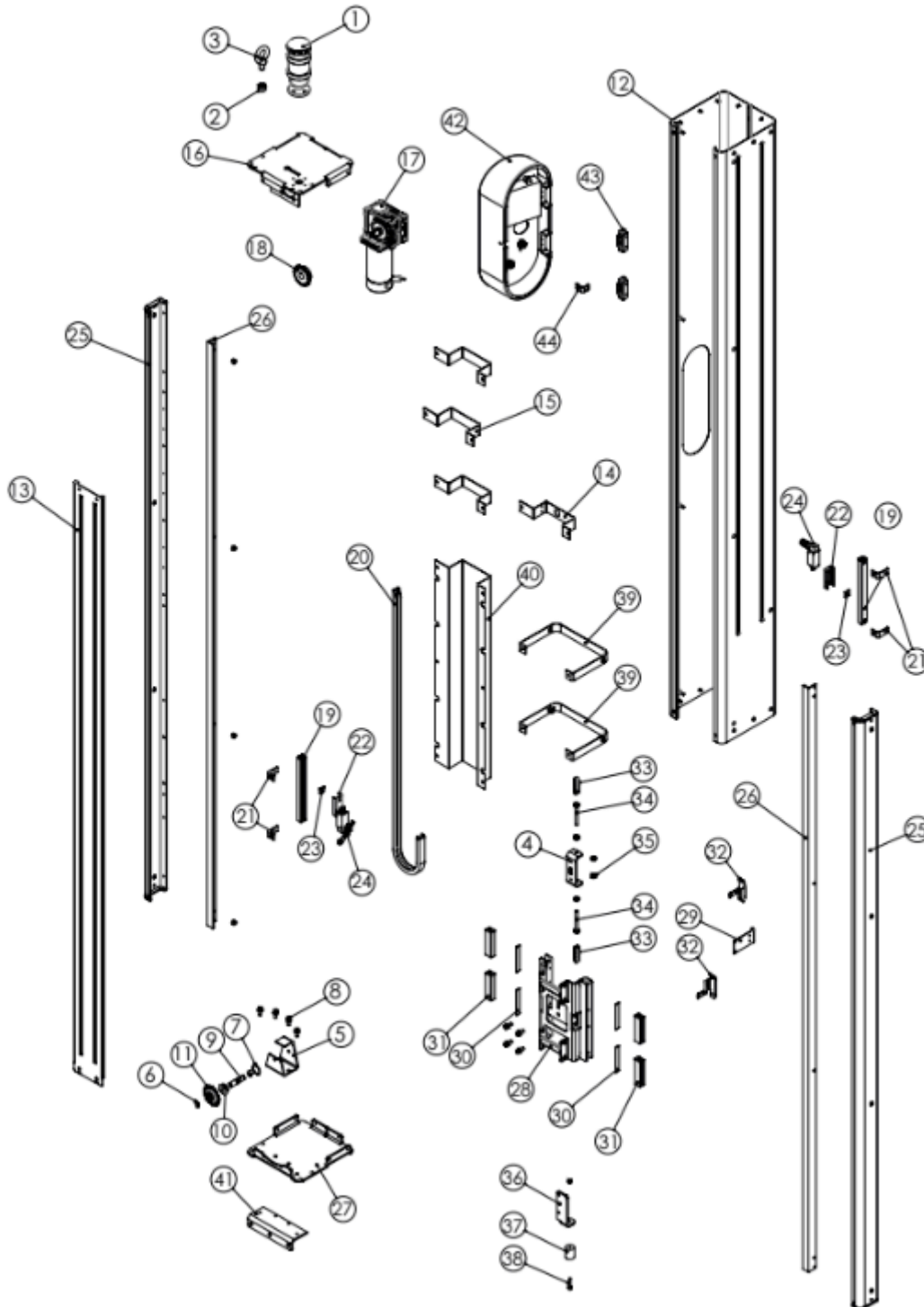


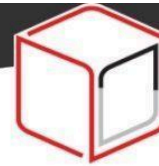
25	1034AN250000000000	Nut, bearing an25	1
26	1034AW250000000000	Bearing shim aw25	1
	303625420000000000	Bearing axk2542	2
	3036AS040000000000	Shim as2542	4
27	FGP602003100000000	Collar	1
28	303090500000000000	Bearing 6905zz	2
29	FGP602001600000010	Balancing block a	12
30	FGP602001700000000	Balancing block b	6
31	FGP601000000000020	Electrical box (rh/lh)	2
32	101112450000000000	Screw m12×40l	2
33	103312000000000000	Nut m12	2
34	7355N1050000000000	Proximity sensor pm12-04n	1
35	101005400000000000	Screw m5×40l	2
36	101408200000000000	Screw m8×20l	1
37	FGP602000100000000	Washer	1
38	FGP602002900000003	Tyre (rear)	1
39	FGP60WG01100000000	Motor	1
40	7355N105R000000000	Limit switch	1
41	FGP602000200000000	Lever	1
42	FGP602002900000003	Tyre (rear)	1
43	101408200000000000	Screw m8×20l	1
44	FGP602000100000000	Washer	1
45	FGP602003000000000	Bearing seat	1
46	FGP602002400000000	Collar	1
47	303000400000000000	Bearing 6004zz	2
48	113142000000000000	C-clip r-42	2
49	FGP602002500000000	Tyre axle shaft	1





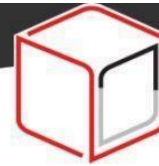
### 7.3 Colonna





No	PART No	DESCRIPTION	QTY	SERVICES
1	FGP60WG02200000000	Warning light assy. (red)	1	
2	103316000000000000	Nut m16	1	
3	FGP60WG02100000000	Suspending hook	1	
4	FGP60C002100000000	Chain adjusting seat	1	
5	FGP60C001902000010	Fixing plate	1	
6	113015000000000000	C-clip s-15	2	
7	113132000000000000	C-clip r-32	1	
8	102508150000000000	Screw m8×15l	2	
9	FGP60C002700000000	Sprocket shaft	1	
10	303000200000000000	Bearing 6002zz	1	
11	FGP60C002600000000	Sprocket	1	
12	FGP60C000100000000	Tower frame	1	
13	FGP60C000300000000	Tower cover	1	
14	FGP60C001500000000	Fixing seat	1	
15	FGP60C001600000000	Fixing seat	3	
16	FGP60C001800000000	Tower top cover	1	
17	FGP60WG02300000000	Reducer motor	1	
	FGP60C002300000000	Reducer motor shaft	1	
18	FGP60C002500000000	Sprocket	1	
19	FGP60C002400000003	Aluminum rails	2	
20	7067X0030000000000	Fixing plate	1	
	7067C0630000000000	Snack wire cover cbo-035.1b	1	
21	FGP60C000800000000	Rail bracket	4	

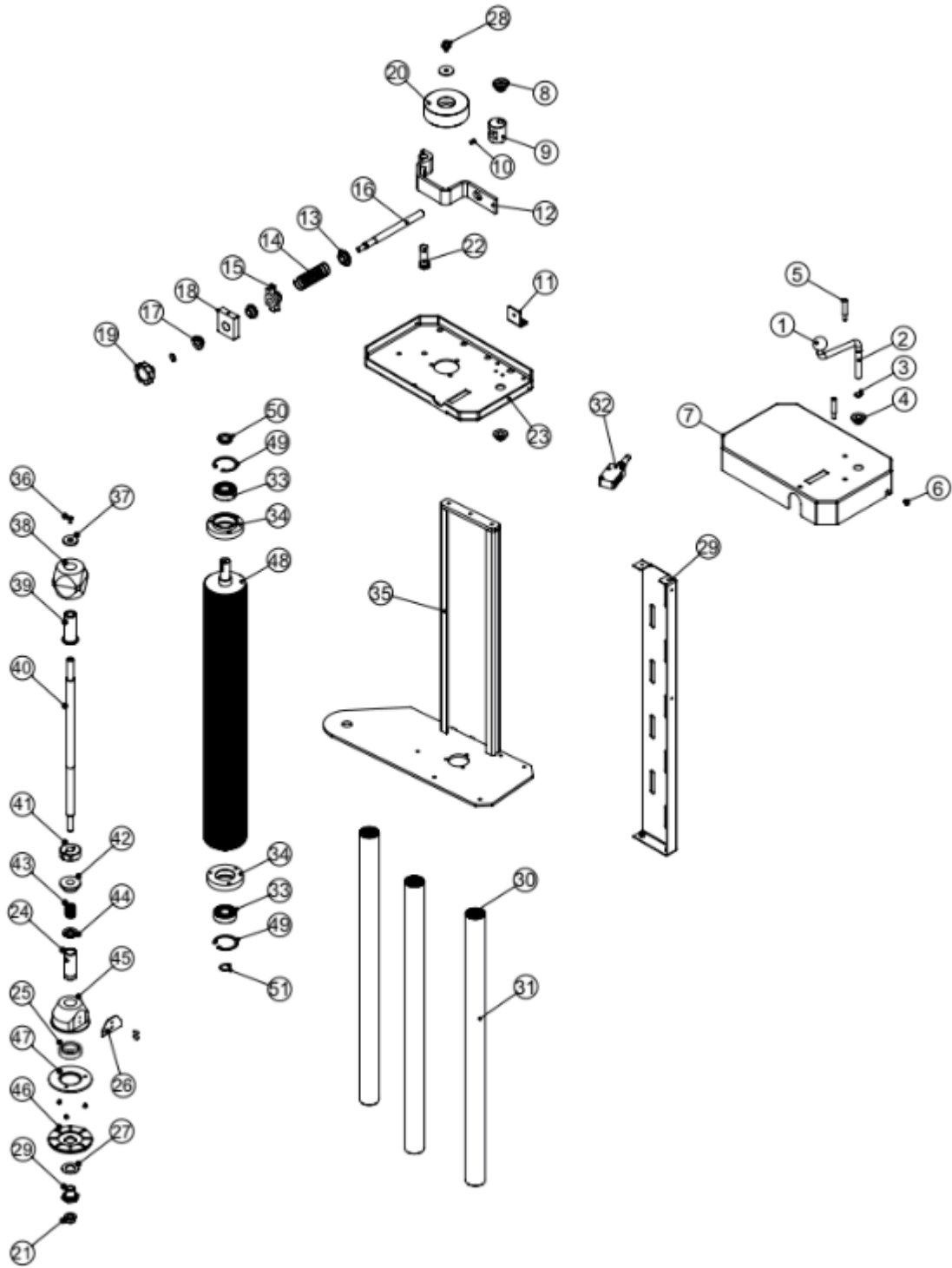


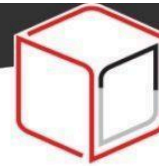


22	FGP60C001000000000	Limit block	2
23	FGP60C001100000000	Fixing plate	2
24	7350TZ040000000000	Limit switch	2
25	FGP60C000200000000	Rail mount	2
26	FGP60C002200000000	Aluminum rails	2
27	FGP60C001901000020	Tower bottom	1
28	FGP60C000400000000	film carriage support	1
29	FGP60C000500000000	Snack wire bracket	1
30	FGP60C000900000000	Shim	4
31	FGP60C003000000006	Slider	4
32	FGP60C000700000000	Sensing plate	2
33	3240S42000000000000	Chain 08b	1
34	FGP60C002800000000	Chain adjustment screw	2
35	103008000000000000	Nut m8 with washer	4
36	FGP60C000600000000	Bracket	1
37	FGP60C002900000000	Buffer block	1
38	102506350000000000	Screw m6×35l	1
39	FGP60C001400000010	Tower bracket	1
40	FGP60C001700000000	Protect plate	1
41	FGP60C001903000010	Tower bottom bracket	1
42	FGP6010007000000000	Control box	1
43	FGP60WG029000000000	Hinger	1
44	FGP6010002000000000	Fix plate	1



### 7.4 Carrello porta bobina STEP ROBOT PALLET WRAPPER BRAKE





No	PART No	DESCRIPTION	QTY	SERVICES
1	FGP38WG02500000000	Handle-m8 teeth	1	
2	FGP61A007800000000	Handle	1	
3	1130100000000000000	C-ring s-10	1	
4	FGP38A008400000000	Bush	2	
5	FGP38A008100000000	Spring plungers	2	
6	1024061000000000000	Screw m6×10l	3	
7	FGP61A000400000000	Cover	1	
8	FGP38WG02800000000	Spring	1	
9	FGP61A007700000000	Wheel	1	
10	1018061000000000000	Screw m6×10l	1	
11	FGP38A005400000000	Fixed board	1	
12	FGP38A000500000000	Brake plate	1	
13	FGP38A008300000000	Block ring	1	
14	FGP38WG02700000000	Stretch spring	1	
15	FGP61A000600000000	Tension adjust seat	1	
16	FGP38A007500000000	Tension adjust screw	1	
17	FGP38A008400000000	Bush	2	
18	FGP61A007600000000	Gear screw fix seat	1	
19	FGP38WG02600000000	Handle	1	
20	FGP38A007900000000	Brake wheel	1	
21	1033120000000000000	Self locking nut m12	1	
22	FGP38A008000000000	Brake shaft	1	
23	FGP61A000300000000	Film carriage unit upper seat	1	
24	FGR214001600000010	Shaft tube	1	
25	3030005000000000000	Bearing 6005zz	1	

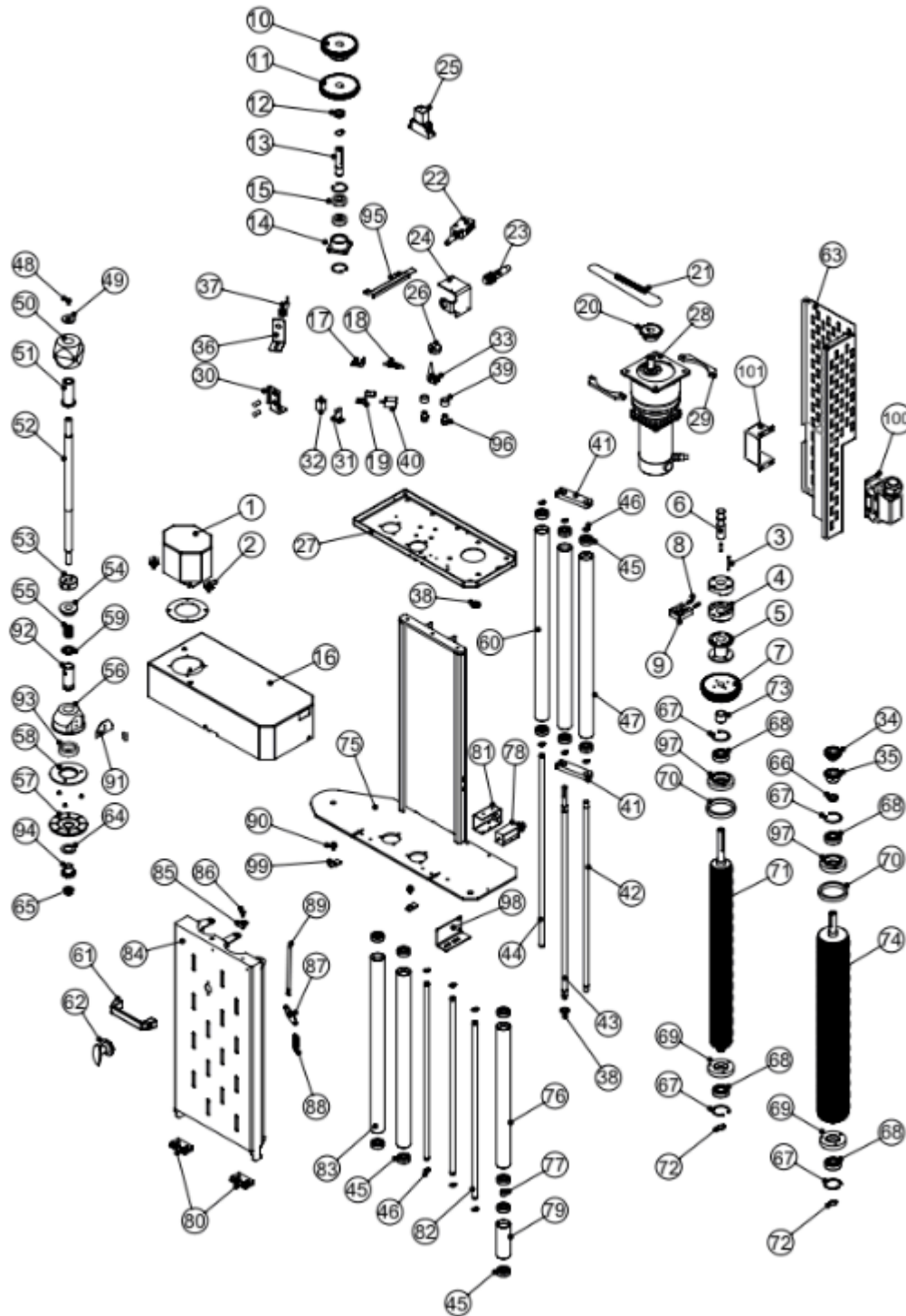


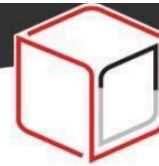


26	FGP18A001000000010	Spring plate	1
27	FGR214001800000000	Washer	1
28	101806120000000000	Screw m6×12l	1
29	FGP61A000200000000	Side plate	1
30	FGP38A006600000000	Roller shaft	3
31	FGP38A006500000000	Roller	3
32	73602M050000000000	Photo sensor	1
33	303020300000000000	Bearing 6203zz	2
34	FGP18A001500000000	Bearing seat	2
35	FGP61A000000000000	Carriage	1
36	102506160000000000	Screw m6×16l	1
37	FGP18A004900000000	Washer	1
38	FGP18WG00200000006	Ring (upper)	2
39	FGP18A000800000000	Sleeve	1
40	FGP18A000700000010	Film seat roller	1
41	FGP18A001400000000	Adjusting ring	1
42	FGP18A001300000004	Ring (lower)	1
43	FGP18WG00100000000	Spring	1
44	303617300000000000	Bearing ax1730	1
45	FGP18A000900000016	Film fix seat	1
46	FGP18A001200000000	Brake disc	1
47	FGR214002000000000	Friction seat	1
48	FGP38A001600000000	Pre-stretch roller	1
49	113142000000000000	C-ring r-42	2
50	FGP18A002800000000	Isolating ring	1
51	113142000000000000	C-ring r-42	1



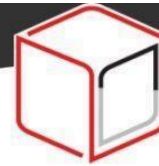
### 7.5 Carrello porta bobina STEP ROBOT PALLET WRAPPER 300%





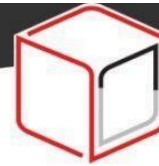
No	PART No	DESCRIPTION	QTY	SERVICES
1	FGP18A000500000000	Supporting cover	1	
2	FGP18WG003000000000	Wing nut m5 x 12l	2	
3	101304500000000000	Screw	4	
4	FGP18WG021000000006	Handle	2	
5	FGP18WG019000000006	Gear pull wheel	1	
6	FGP18A003200000000	Position shaft	1	
	FGP18A104800000000	Slip gear 200% & 250%	1	
7	FGP18A004800000000	Slip gear 230% & 300%	1	
	FGP18A204800000000	Slip gear 150% & 250%	1	
8	FGP18WG018000000000	Spring	2	
9	FGP18WG020000000006	Safety button	1	
	FGP18A1047000000006	Fixed gear 41t→250%	1	
10	FGP18A0047000000006	Fixed gear 42t→300%	1	
	FGP18A2047000000006	Fixed gear 36t→250%	1	
	FGP18A1046000000006	Fixed gear 44t→200%	1	
11	FGP18A0046000000006	Fixed gear 46t→230%	1	
	FGP18A2046000000006	Fixed gear 42t→150%	1	
12	FGP18A0029000000000	Isolating ring	1	
13	FGP18A0044000000000	Fixed gear shaft	1	
14	FGP18A0025000000000	Bearing seat	1	
15	3030003000000000000	Bearing 6003zz	2	
16	FGP18A0004000000000	Top cover	1	
17	FGP18A0054000000000	Spring seat	1	
18	FGP18WG022000000000	Spring	1	
19	FGP18A0052000000000	Bracket	1	





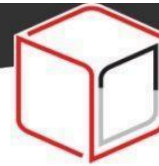
20	FGP18A004100000000	Chain gear 17t	1
21	3240S3570000000000	Chain	1
22	73602M050000000000	Photo sensor	1
23	735500030000000000	Analog switch (xs4-p18)	1
24	FGP18A005100000000	Resistance fixed seat	1
25	RXM2LB1BD000000000	Relay	1
26	FGP18A003100000000	Sensor cam	1
27	FGP18A000300000000	Carriage unit upper seat	1
28	FGP60WG01700000000	Reducer motor	1
29	FGP18A006100000000	Plate	2
30	FGP18A005000000000	Lamp bracket	1
31	FGP18A005300000000	Limit fixed seat	1
32	FGP18A015000000000	Proximity sensor	1
33	FGP18A006800000000	Arm	1
	FGP18A1045000000000	Gear →200% &250%	1
34	FGP18A004500000000	Gear →230% &300%	1
	FGP18A2045000000000	Gear →150% &250%	1
35	FGP18A004200000000	12t chain wheel	1
36	FGP18A005500000000	Proximity switch seat	1
37	7355N1050000000000	Proximity sensor pm12-04n	1
38	FGP18A001800000005	Bush	2
39	FGP18A003600000000	Buffer block	2
40	7355N1150000000000	Proximity sensor nbn5-f7-e0	1
41	FGP18A006700000000	Arm	2
42	FGP18A002400000000	Roller shaft	1
43	FGP18A001900000000	Swinging bar shaft	1





44	FGP18A006600000000	Roller shaft	1
45	303020100000000000	Bearing 6201zz	14
46	113012000000000000	C-ring s-12	1
47	FGP18A002200000003	Roller tube	2
48	102906120000000000	Screw m6 x 12l	1
49	FGP18A004900000000	Washer	1
50	FGP18WG00200000006	Ring (upper)	2
51	FGP18A000800000000	Sleeve	1
52	FGP18A000700000010	Film seat roller	1
53	FGP18A001400000000	Adjusting ring	1
54	FGP18A001300000004	Ring (lower)	1
55	FGP18WG00100000000	Spring	1
56	FGP18A000900000016	Film fix seat	1
57	FGP18A001200000000	Brake disc	1
58	FGR214002000000000	Friction seat	1
59	303617300000000000	Bearing ax1730	1
60	FGP60A006500000003	Roller tube	1
61	FGP18WG01400000006	Handle bar	1
62	FGP18WG01300000000	Door knob	1
63	FGP60A000200000000	Side plate	1
64	FGR214001800000000	Washer	1
65	103312000000000000	Self locking nut m12	1
66	FGP18A002800000000	Isolating ring	1
67	113142000000000000	C-ring r-42	2
68	303020300000000000	Bearing 6203zz	4
69	FGP18A001500000000	Bearing seat	2





70	FGP18WG00500000000	Protection ring	2
71	FGP18A001700000000	Pre-stretch roller	1
72	113017000000000000	C-ring s-17	1
73	FGP18A004800000000	Isolating ring	1
74	FGP18A001600000000	Pre-stretch roller	1
75	FGP18A000000000000	Elevator unit seat	1
76	FGP18A002000000003	Roller tube	1
77	FGP18A002600000000	Sleeve	1
78	FGP18WG01700000000	Solenoid(tau-1358 dc24v)	1
79	FGP18A002100000003	Roller tube	1
80	FGP18WG00600000003	Hinge	2
81	FGP18A006900000000	Solenoid bracket	1
82	FGP18A002300000000	Roller shaft	3
83	FGP18A006400000003	Roller tube	2
84	FGP18A000600000000	Safety door	1
85	FGP18A003000000000	Security key	1
86	102906120000000000	Screw m6x12l	1
87	FGP18A006000000000	Plate	1
88	FGP18WG02200000000	Spring	1
89	FGP18A003900000000	Door bolt	1
90	102406100000000000	Screw m6x10l	2
91	FGP18A001000000010	Spring plate	1
92	FGR214001600000010	Shaft tube	1
93	303000500000000000	Bearing 6005zz	1
94	FGR214001700000000	Shaft nut	1
95	FGP60A007000000000	Protection cover	1
96	FGP60A002700000000	Fixed tube	2





97	FGP18A001500000010	Bearing seat	2
98	FGP60A006300000000	Bracket	1
99	FGP60A007100000000	Fixed plate	2
100	FGP60WG01900000000	Heavy load joint	1
101	FGP60A007200000000	Protection cover	1

## 8.1 Electric capacity

### 1. Consumo di corrente

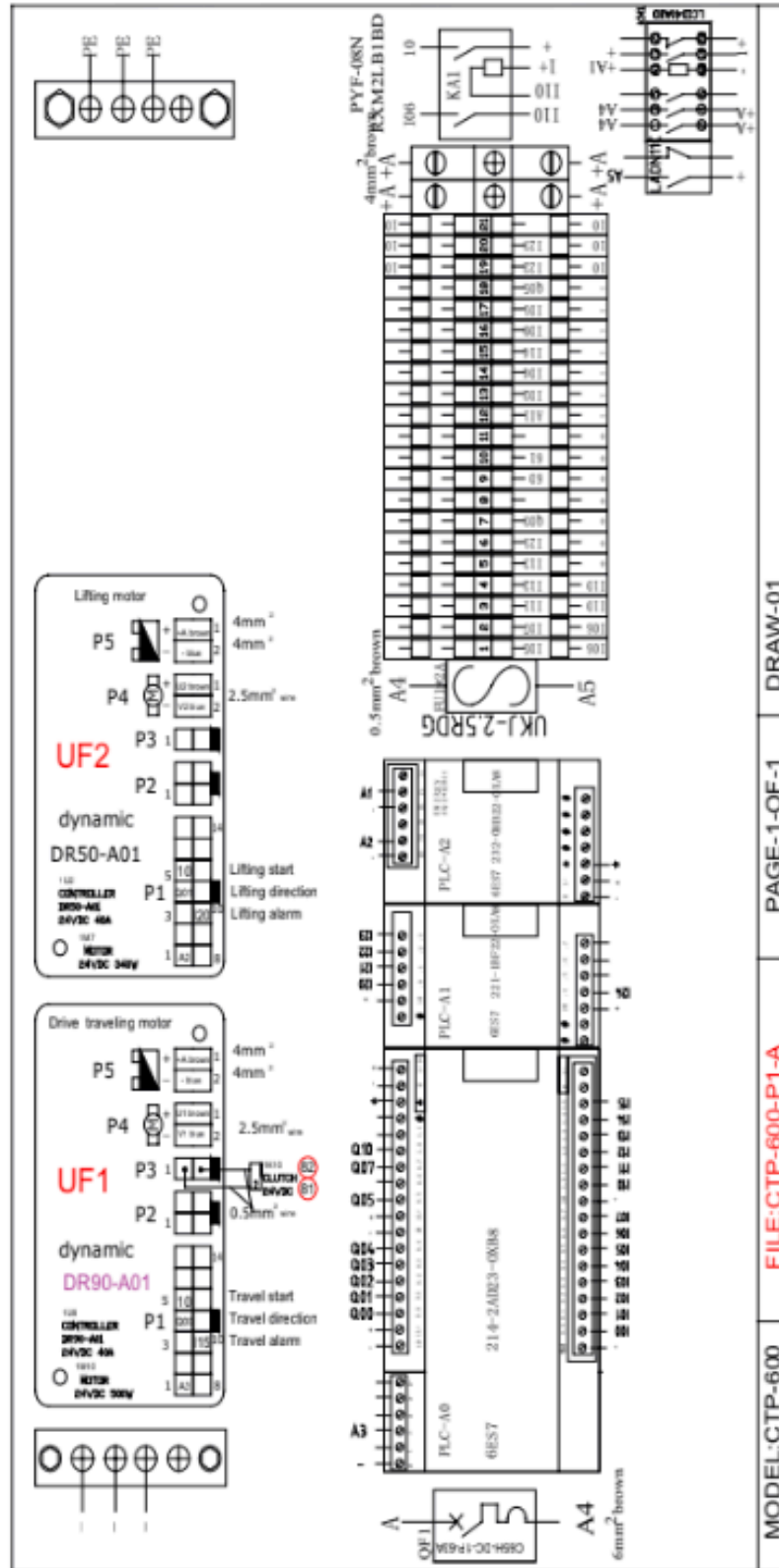
	STEP ROBOT PALLET WRAPPER BRAKE	STEP ROBOT PALLET WRAPPER 300%
Motore carrello con prestiro del film	-	280w,24V,DC
Motore di avvolgimento	500w, 24V,DC	500w, 24V,DC
Motore si sollevamento	340w, 24V,DC	340w, 24V,DC
IP	54	54

### 2. Ingresso batteria: 110V / 220V monofase





### 8.2 WIRING DIAGRAMS STEP ROBOT PALLET WRAPPER BRAKE

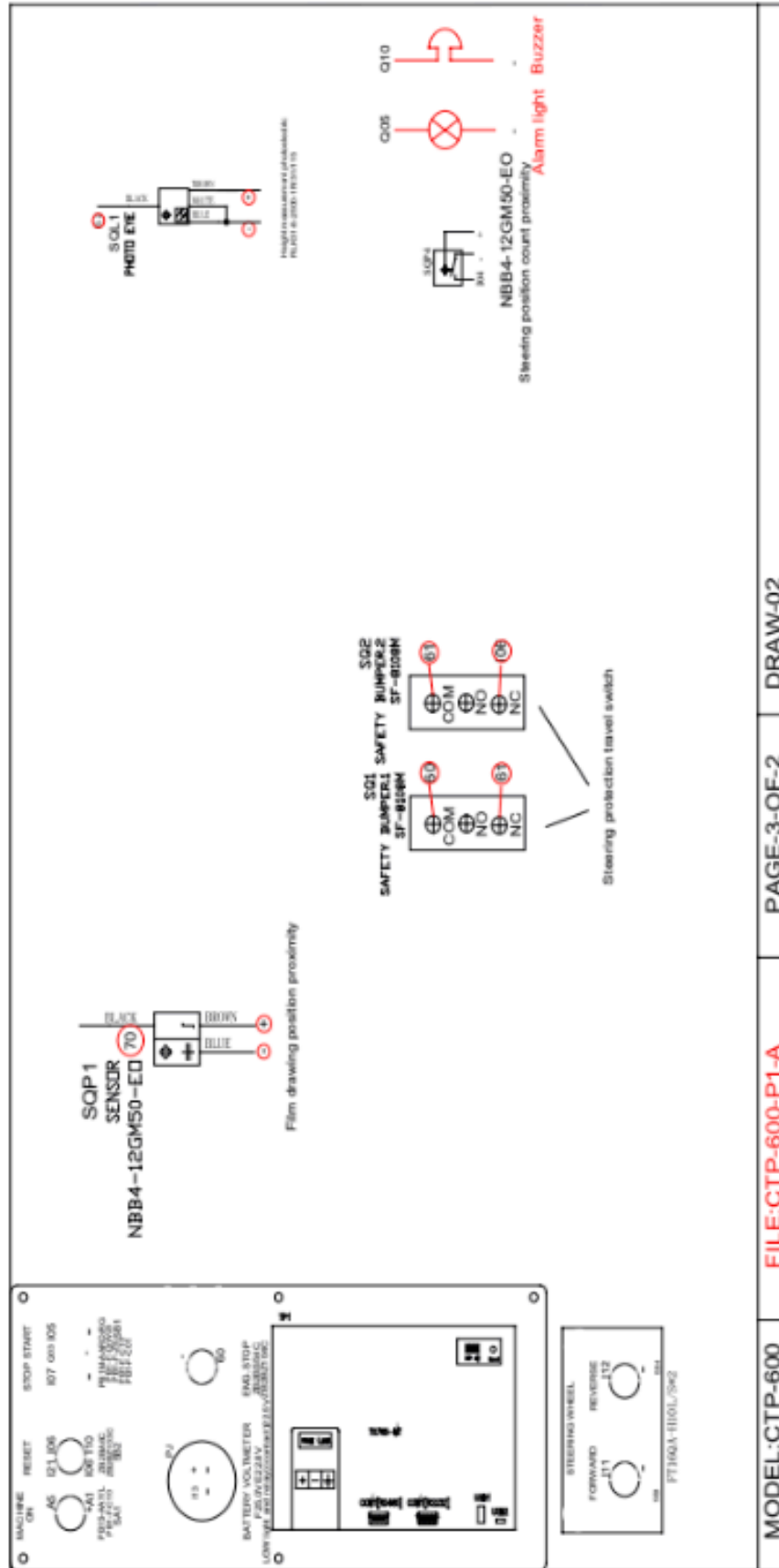


DRAW-01

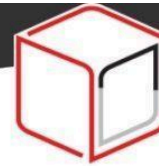
PAGE-1-OF-1

FILE:CTP-600-P1-A

MODEL:CTP-600



MODEL:CTP-600 FILE:CTP-600-P1-A PAGE-3-OF-2 DRAW-02



**ELECTRICAL PARTS LIST OF STEP ROBOT PALLET WRAPPER BRAKE**

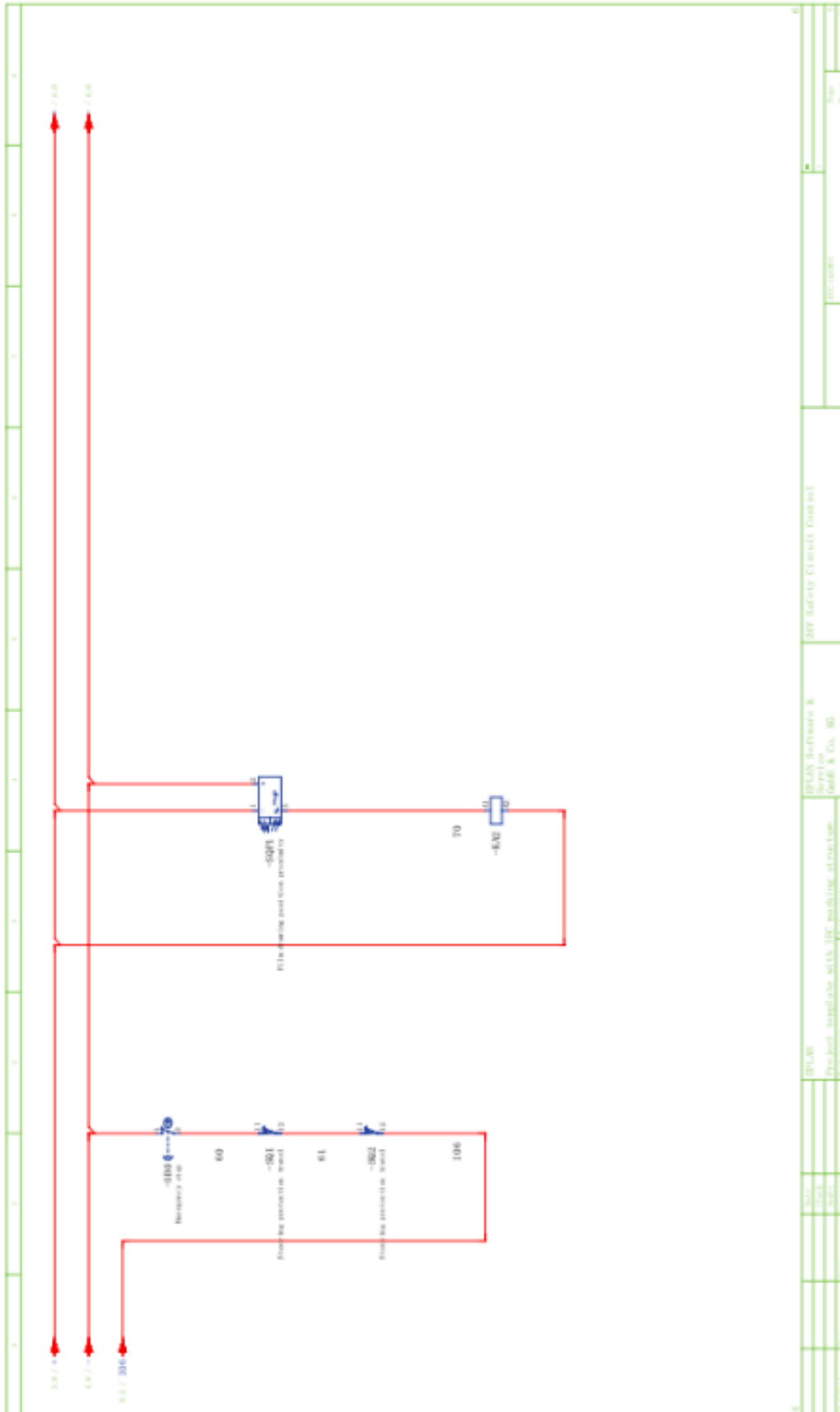
<b>No.</b>	<b>PART No.</b>	<b>DESCRIPTION</b>	<b>QTY</b>
1	Breaker	C65H-DC-1P-63A	
2	Breaker	DZ47-60 1P25A	
3	Siemens PLC	6ES7 214-2AD23-OXB8	
4	Siemens extension module	6ES7 221-1BF22-OXA8	
5	Siemens analog quantity module	6ES7 232-0HB22-OXA8	
6	Touch screen	TG765-MT	
7	Contactator	LC1D40BD	
8	DC motor driver	DR50-A01	
9	DC motor driver	DR90-A01	
10	Travel switch	SF-8108M	
11	Proximity switch1	NBB4-12GM50-EO	
12	Intermediate relay	RXM2LB1BD	
13	Suction tube (electromagnet)	TAU-1358	
14	Diffuse photoelectric	RLK31-8-2500-1R/31/115	
15	Switching power supply	ZB2BG2C	
16	Reset button	ZB2BA6C	
17	Start/stop button	PB1M-AARD/RG	
18	Emergency stop button	ZB2BS54C	
19	Battery voltmeter	F25.0V E22.8V	
20	Steering wheel	PB1J-10/G	
21	Safety reset button	ZB2BW31C	

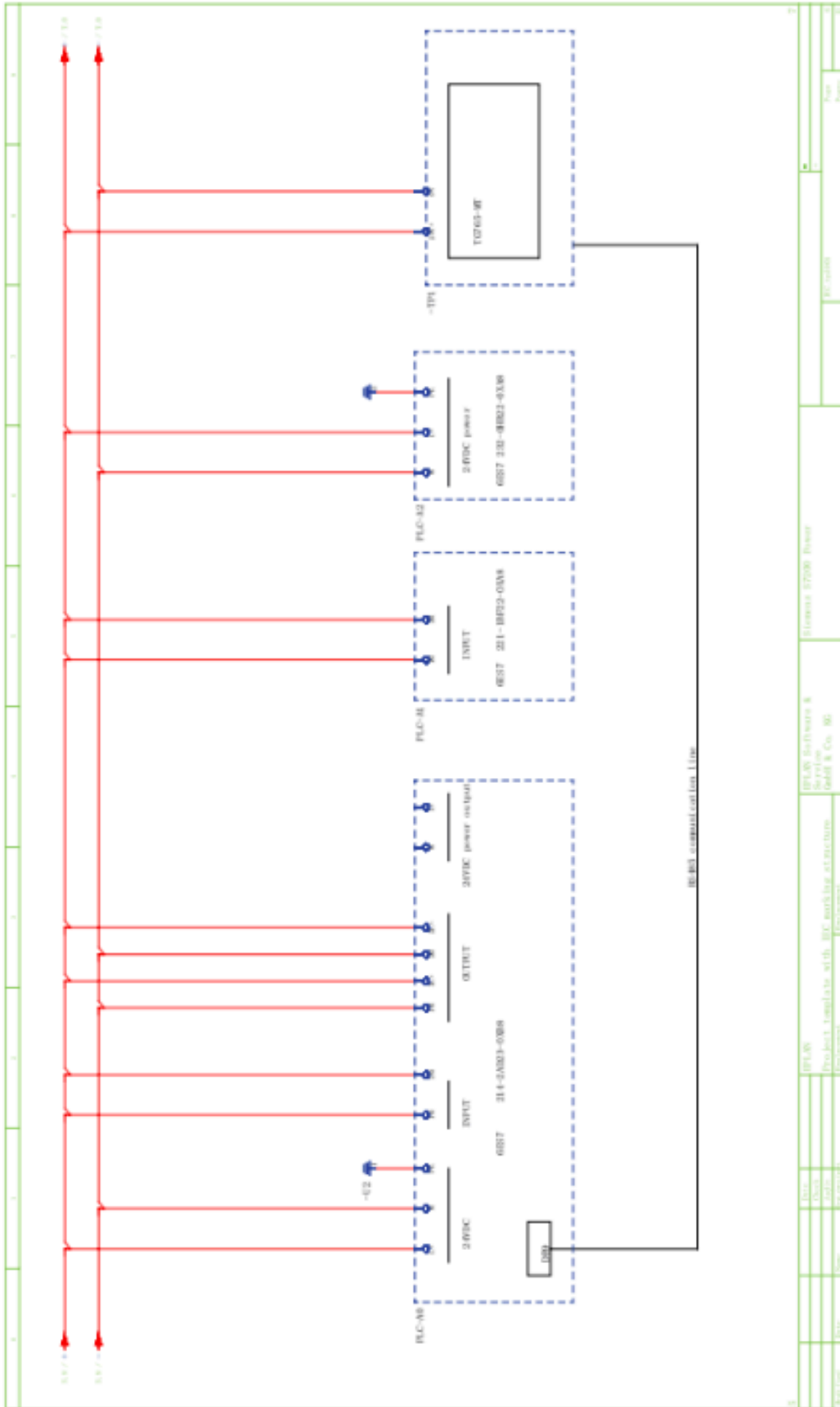


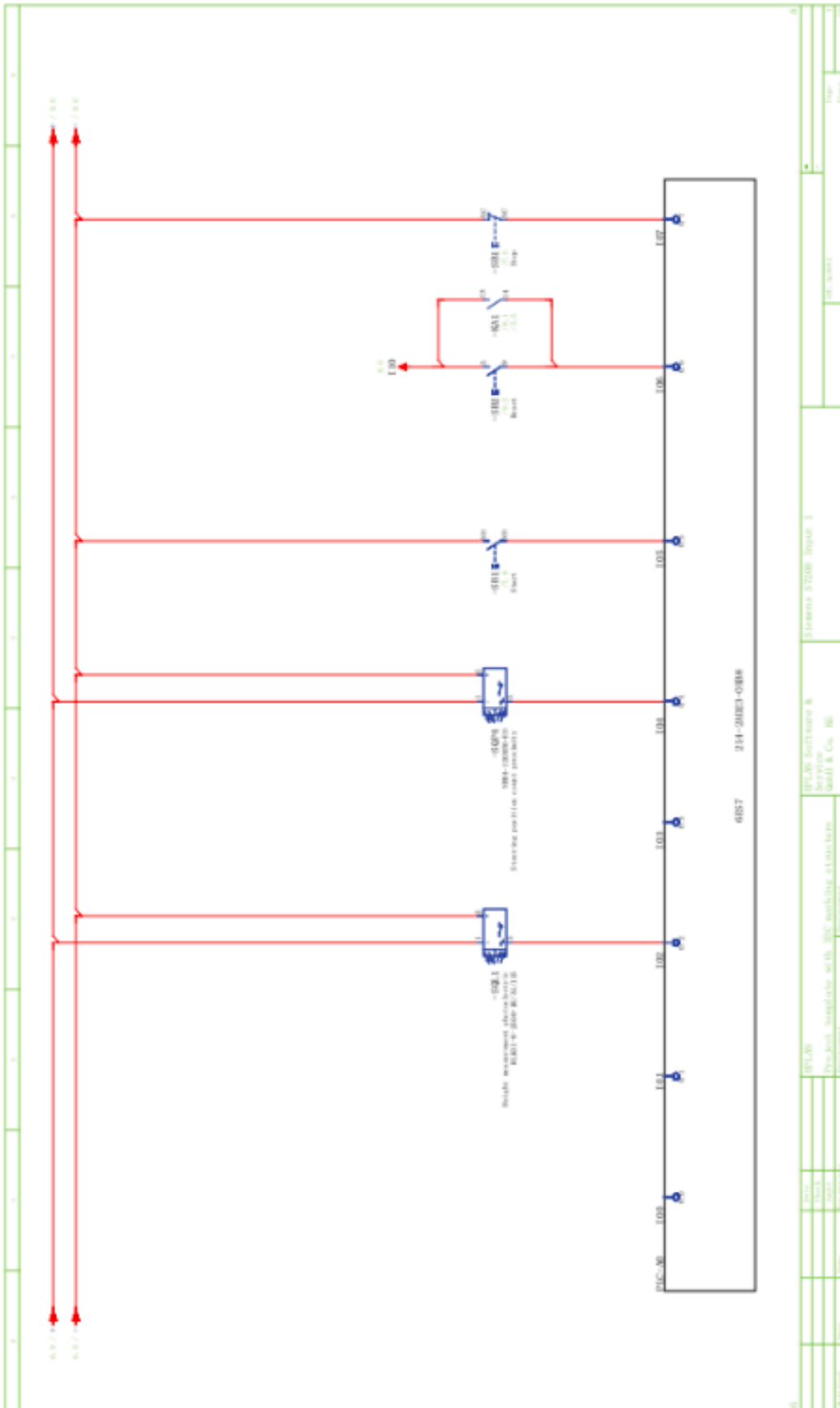


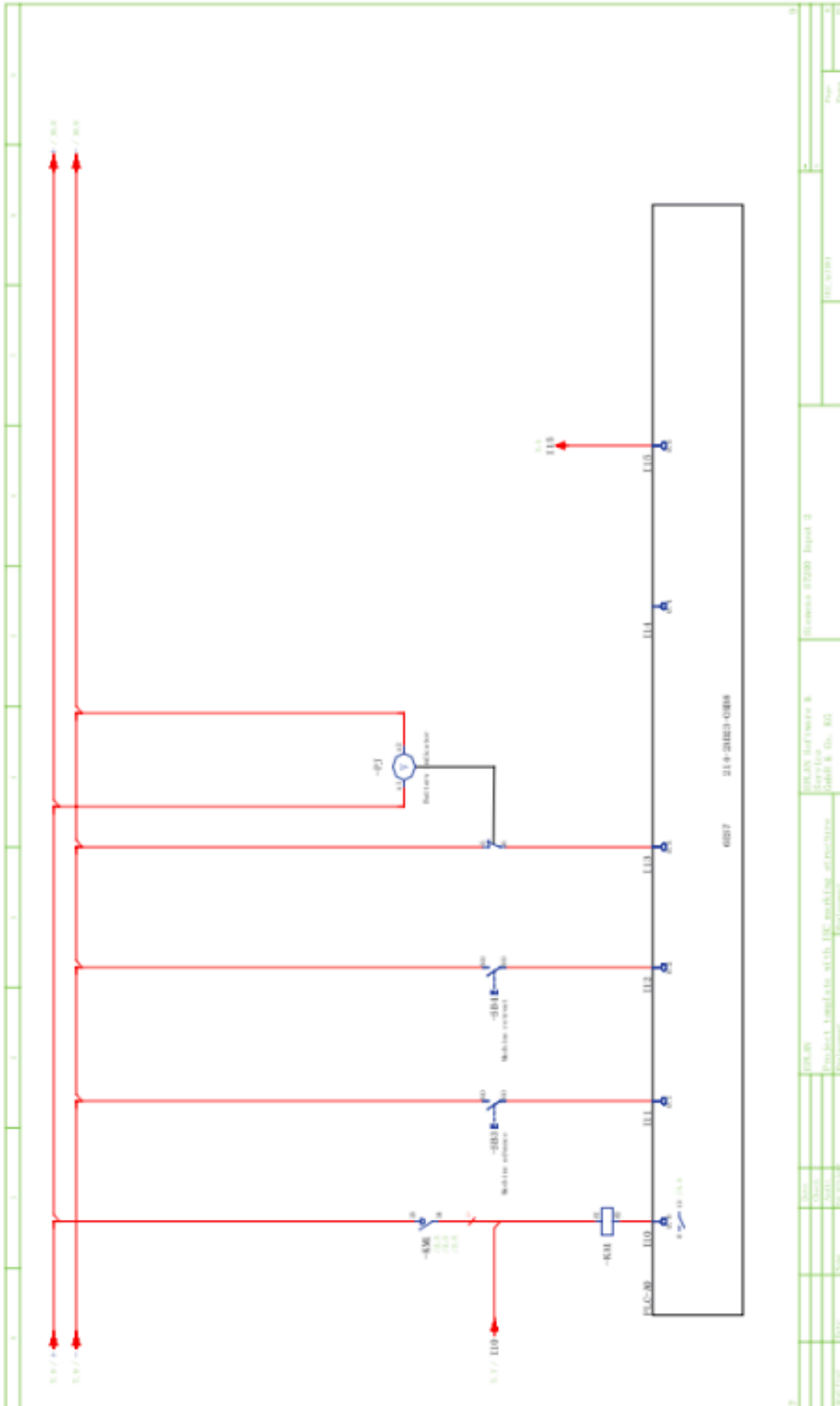




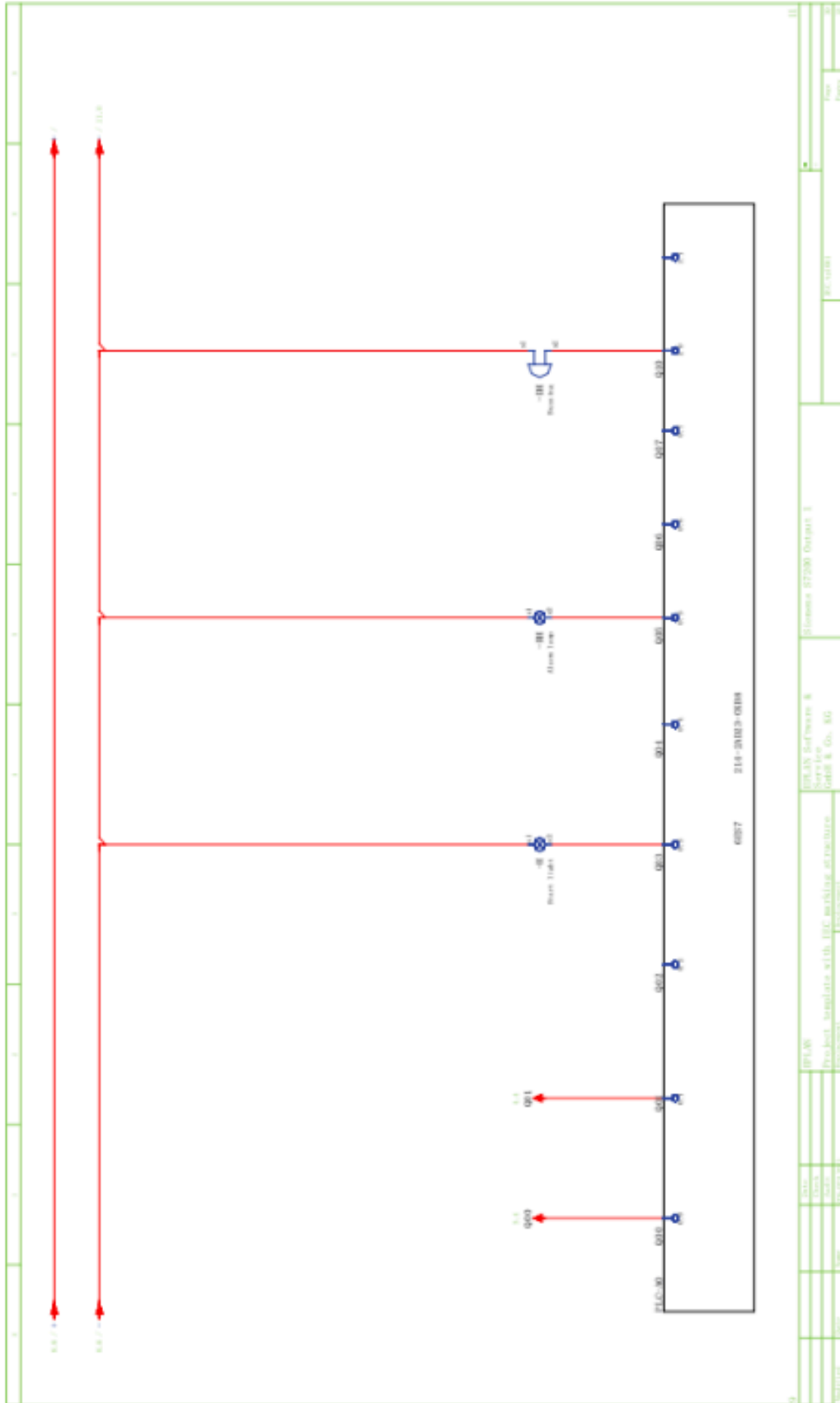










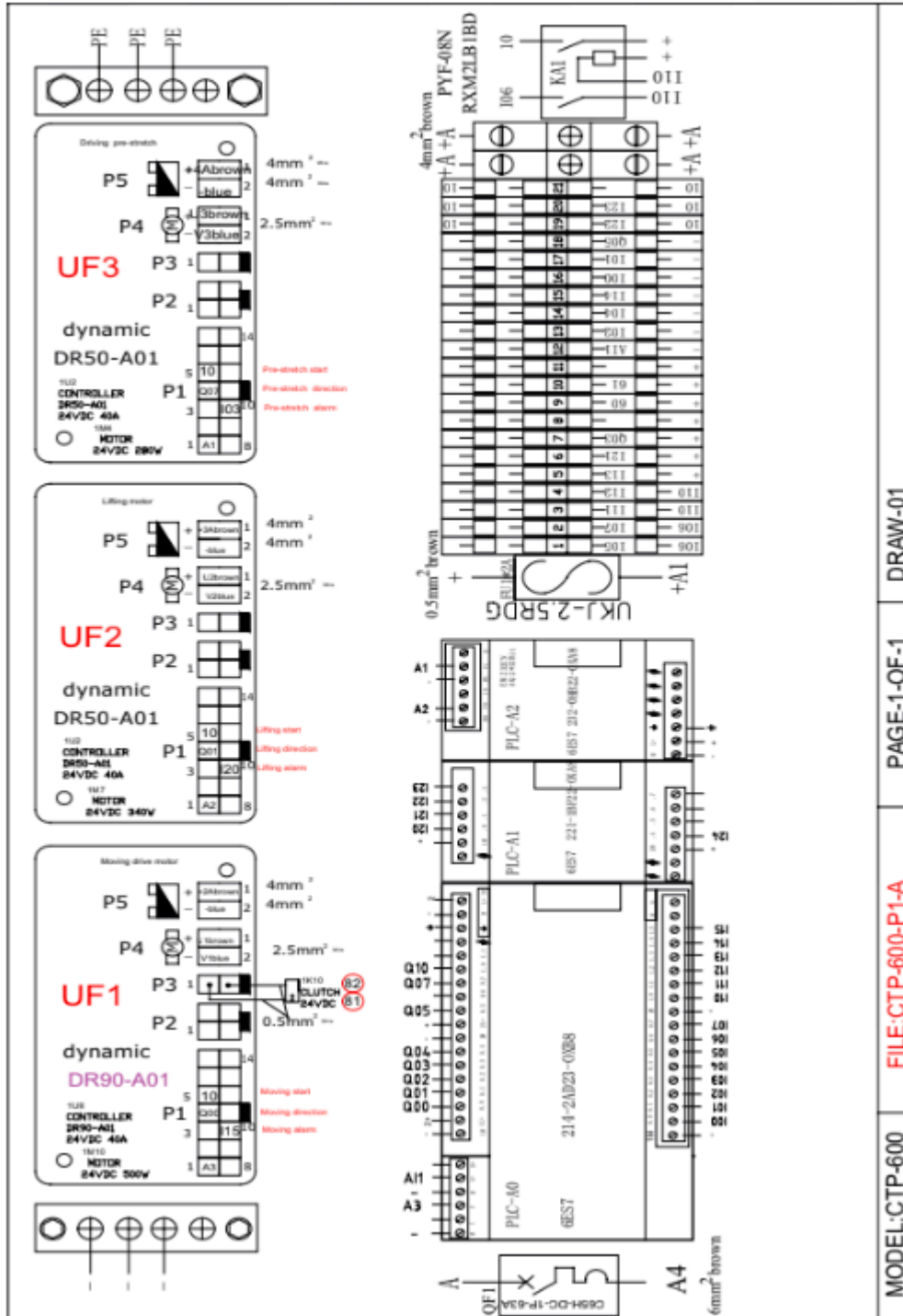








### 8.3 WIRING DIAGRAMS STEP ROBOT PALLET WRAPPER 300%



DRAW-01

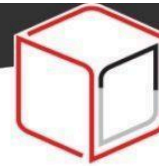
PAGE-1-OF-1

FILE:CTP-600-P1-A

MODEL:CTP-600





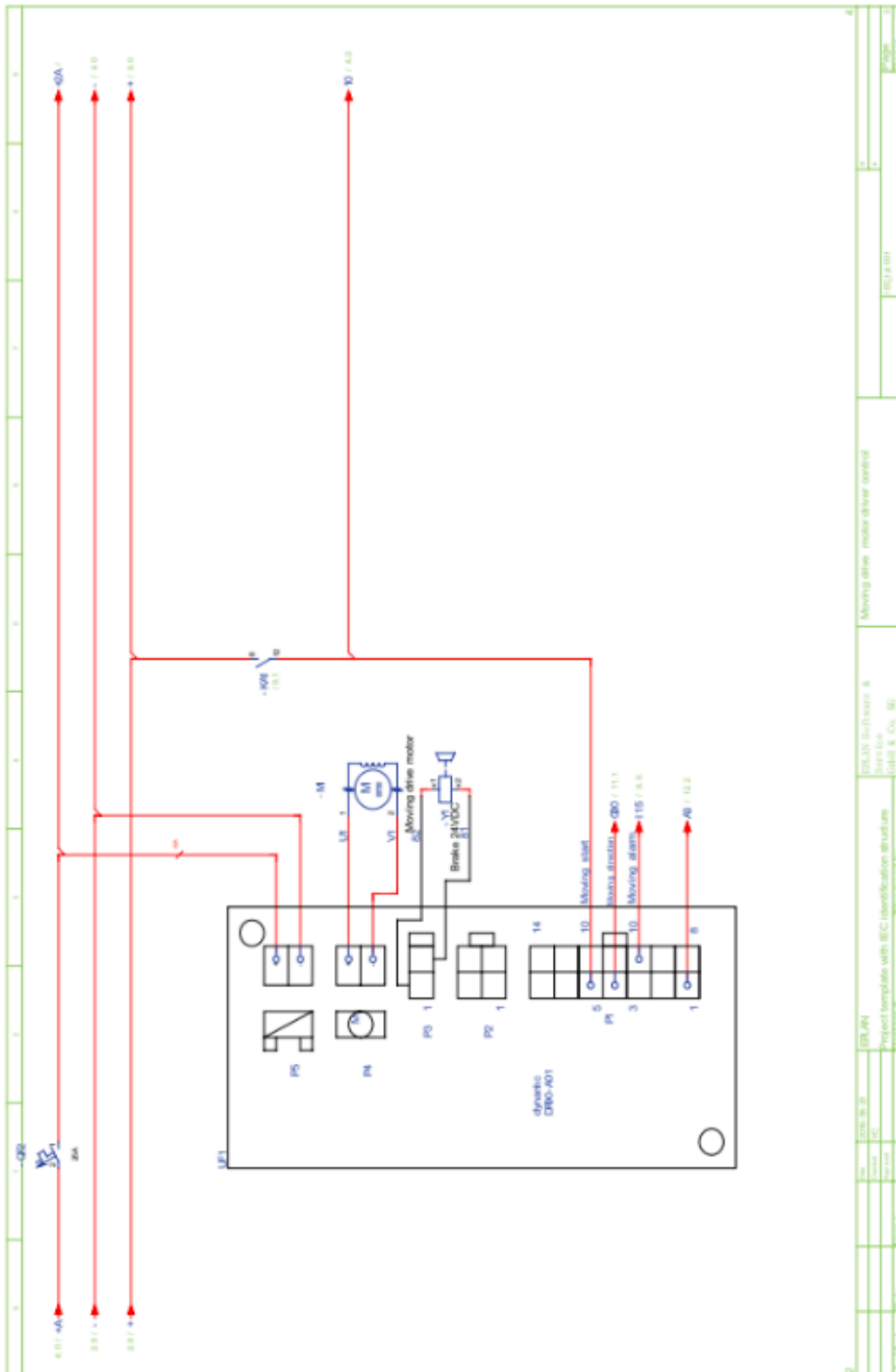


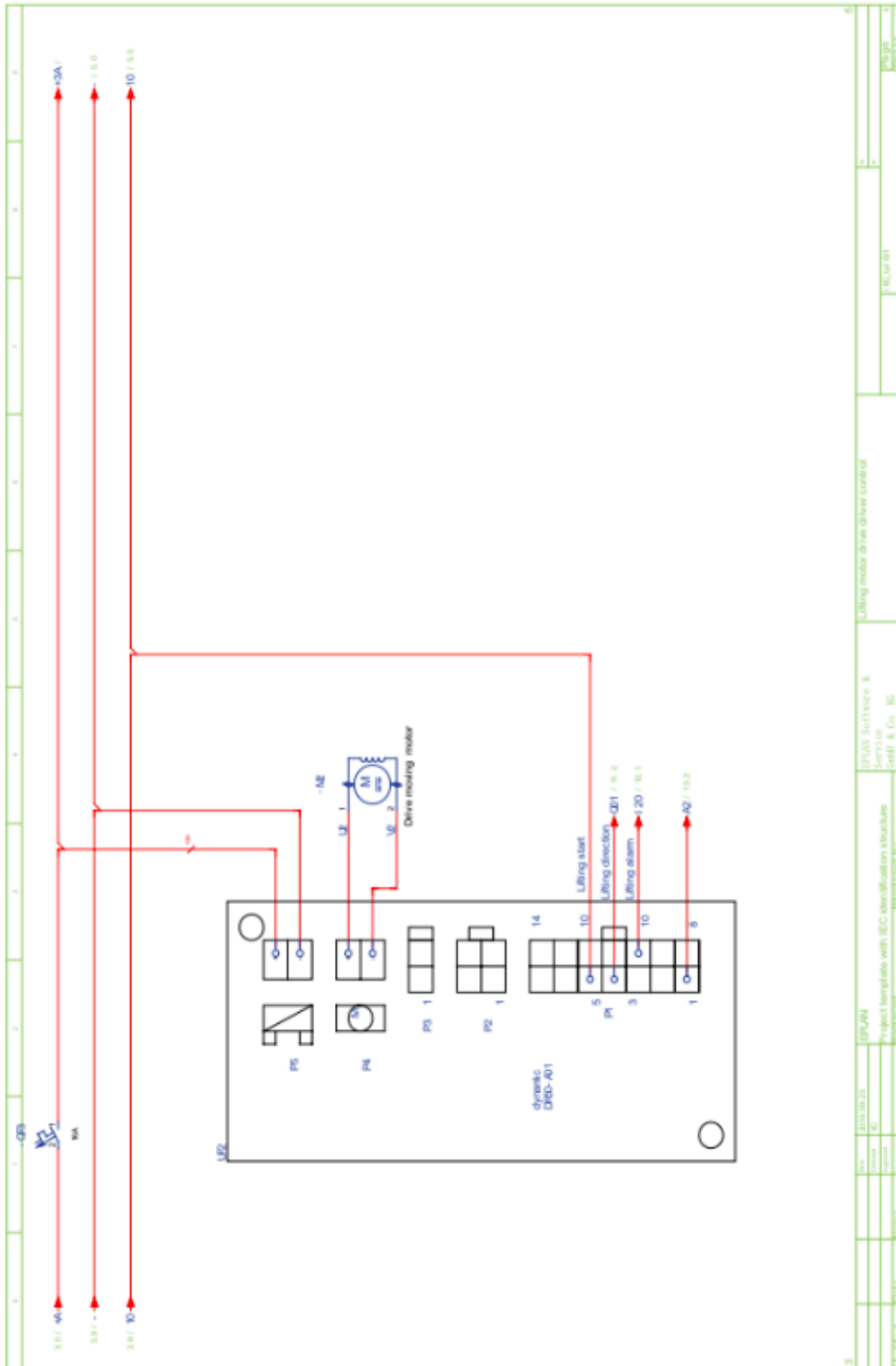
**ELECTRICAL PARTS LIST OF STEP ROBOT PALLET WRAPPER 300%**

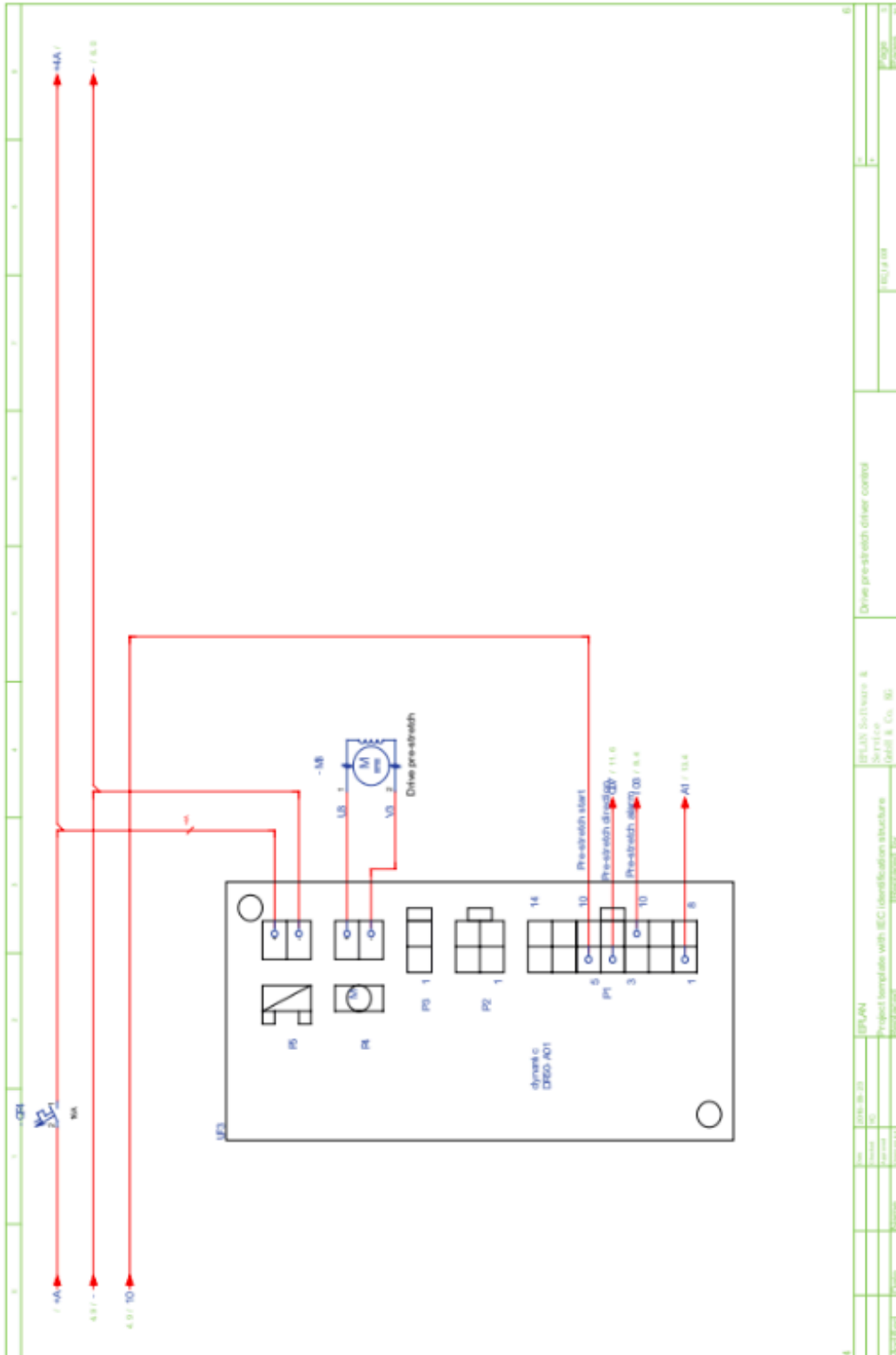
<b>No.</b>	<b>PART No.</b>	<b>DESCRIPTION</b>	<b>QTY</b>
1	Circuit breaker	C65H-DC-1P-63A	1
2	Circuit breaker	DZ47-60 1P25A	3
3	Siemens PLC	6ES7 214-2AD23-OXB8	1
4	Siemens expansion	6ES7 221-1BF22-OXA8	1
5	Siemens simulation module	6ES7 232-0HB22-0XA8	1
6	Touch screen	TG765-MT	1
7	Contactora	LC1D40ABD	1
8	DC motor driver	DR50-A01	2
9	DC motor driver	DR90-A01	1
10	Stroke switch	SF-8108M	2
11	Proximity switch	NBB4-12GM50-EO	2
12	Intermediate electric relay	NBN5-F7-EO	2
13	Tension sensor	LR18XCN08LUM-E2	1
14	Intermediate electric relay	RXM2LB1BD	2
15	Diffuse reflection photoelectric	RLK31-8-2500-1R/31/115	1
16	Reset button	ZB2BA6C	1
17	Start/stop button	PB1M-AARD/RG	1
18	Emergency Stop Button	ZB2BS54C	1
19	Battery volt meter	F25.0V E22.8V	1
20	Steering wheel	FT16QA-H10L/S	2
21	Suction roller (electric magnet)	TAU-1358	1



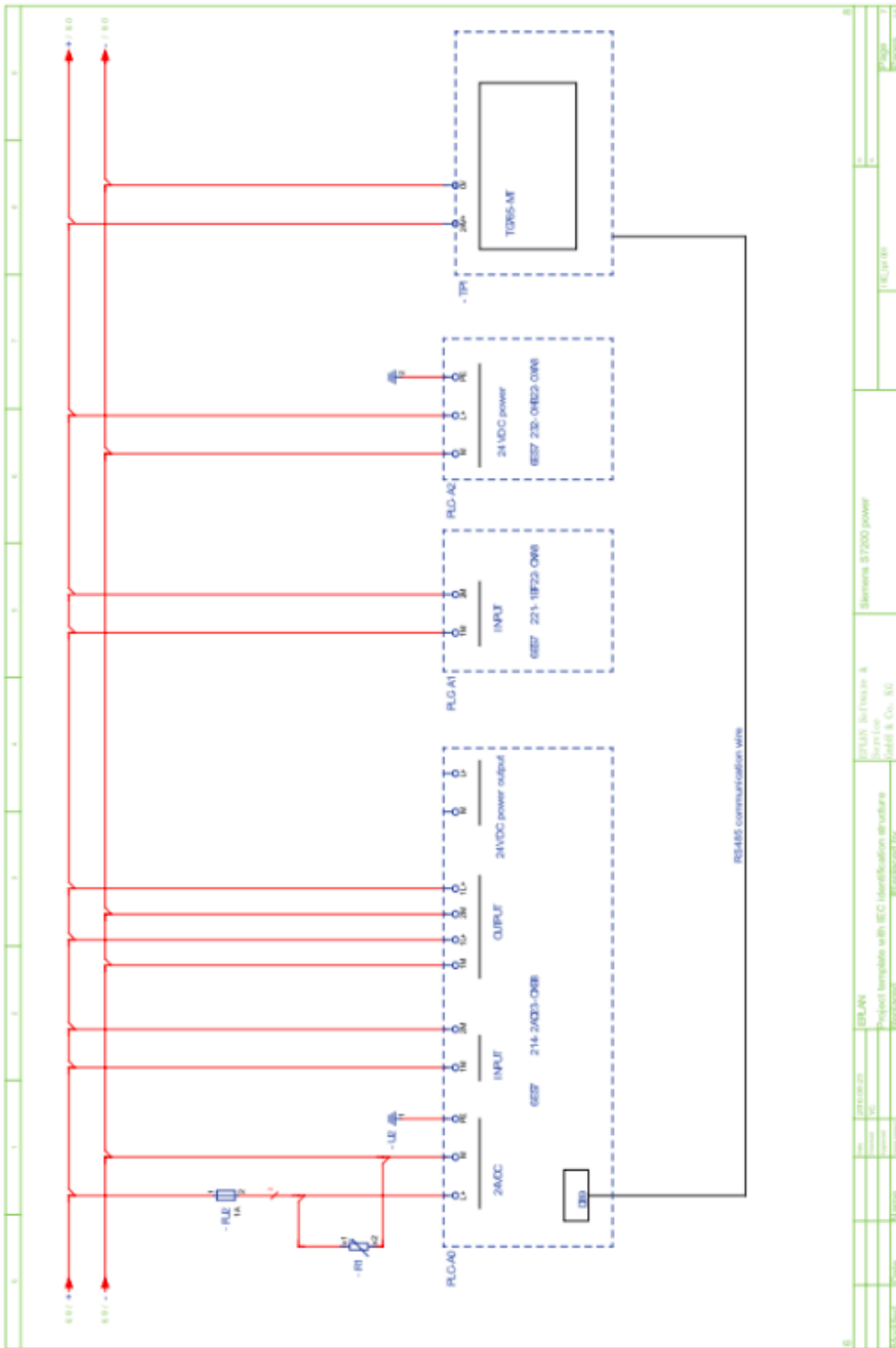












Symbol	Description
PLC-A1	PLC
PLC-A2	PLC
PLC-A3	PLC
PLC-A4	PLC
PLC-A5	PLC
PLC-A6	PLC
PLC-A7	PLC
PLC-A8	PLC
PLC-A9	PLC
PLC-A10	PLC
PLC-A11	PLC
PLC-A12	PLC
PLC-A13	PLC
PLC-A14	PLC
PLC-A15	PLC
PLC-A16	PLC
PLC-A17	PLC
PLC-A18	PLC
PLC-A19	PLC
PLC-A20	PLC
PLC-A21	PLC
PLC-A22	PLC
PLC-A23	PLC
PLC-A24	PLC
PLC-A25	PLC
PLC-A26	PLC
PLC-A27	PLC
PLC-A28	PLC
PLC-A29	PLC
PLC-A30	PLC
PLC-A31	PLC
PLC-A32	PLC
PLC-A33	PLC
PLC-A34	PLC
PLC-A35	PLC
PLC-A36	PLC
PLC-A37	PLC
PLC-A38	PLC
PLC-A39	PLC
PLC-A40	PLC
PLC-A41	PLC
PLC-A42	PLC
PLC-A43	PLC
PLC-A44	PLC
PLC-A45	PLC
PLC-A46	PLC
PLC-A47	PLC
PLC-A48	PLC
PLC-A49	PLC
PLC-A50	PLC
PLC-A51	PLC
PLC-A52	PLC
PLC-A53	PLC
PLC-A54	PLC
PLC-A55	PLC
PLC-A56	PLC
PLC-A57	PLC
PLC-A58	PLC
PLC-A59	PLC
PLC-A60	PLC
PLC-A61	PLC
PLC-A62	PLC
PLC-A63	PLC
PLC-A64	PLC
PLC-A65	PLC
PLC-A66	PLC
PLC-A67	PLC
PLC-A68	PLC
PLC-A69	PLC
PLC-A70	PLC
PLC-A71	PLC
PLC-A72	PLC
PLC-A73	PLC
PLC-A74	PLC
PLC-A75	PLC
PLC-A76	PLC
PLC-A77	PLC
PLC-A78	PLC
PLC-A79	PLC
PLC-A80	PLC
PLC-A81	PLC
PLC-A82	PLC
PLC-A83	PLC
PLC-A84	PLC
PLC-A85	PLC
PLC-A86	PLC
PLC-A87	PLC
PLC-A88	PLC
PLC-A89	PLC
PLC-A90	PLC
PLC-A91	PLC
PLC-A92	PLC
PLC-A93	PLC
PLC-A94	PLC
PLC-A95	PLC
PLC-A96	PLC
PLC-A97	PLC
PLC-A98	PLC
PLC-A99	PLC
PLC-A100	PLC

















**CONTACT US FOR MORE INFORMATION**

**Denmark: +45 7027 2220**

**Spain: +34 699 900 987**

**Italy: +39 351 988 0682**

**USA: +1 310 773 3423**

**Sweden: +46 31 799 5398**

**Hongkong: +852 8170 1025**

**Philippines: +63 916 777 5299**

